

CF OPERATING PROCEDURE  
NO. 70-1

STATE OF FLORIDA DEPARTMENT  
OF  
CHILDREN AND FAMILIES  
TALLAHASSEE, February 2024

facilities acquisition and management

### LEASING

This operating procedure provides Headquarters and Region General Services staff with policy and procedures to procure the wide variety of lease space necessary to meet all programs and operational requirements. The parameters are established by Section 255.25, Florida Statutes and Chapters 60H-1 thru 60H-8, Florida Administrative Code. the operating procedure outlines the step by step processes compiled in order to maintain a consistent standard in leasing operations and ensure that all legal and administrative procedures are followed to maintain public trust in our leasing program.

BY DIRECTION OF THE SECRETARY:

Mathew Howard  
Staff director of general services

#### SUMMARY OF REVISED, ADDED, OR DELETED MATERIAL

Revised and updated Chapters 1, 2, 3, 5, 6, 7, 8, 9, 10, 11,  
and 14

---

This operating procedure superseded CFOP 70-1 dated May 1, 2020.

OPR: ASG

DISTRIBUTION: X: OSGC; Regional Managing Directors; Region General Services Managers

Table of Contents

Chapter 1 - GENERAL INFORMATION.....1-1

Chapter 2 - LEASING APPROVAL PROCESS.....2-1

Chapter 3 - CERTIFYING SPACE NEEDS.....3-1

Chapter 4 - TENANT BROKER.....4-1

Chapter 5 - LEASES UNDER 5,000 SQ./FT. (QUOTE).....5-1

Chapter 6 - COMPETITIVE PROCUREMENTS OVER 5,000 SQ./FT. (ITN, RFP, ITB).....6-1

Chapter 7 - STAY IN PLACE.....7-1

Chapter 8 – MODIFICATION.....8-1

Chapter 9 - PRIOR APPROVAL.....9-1

Chapter 10 - FREE LEASE – SUBLEASE.....10-1

Chapter 11 - TENANT AT WILL and CHANGE OF OWNERSHIP.....11-1

Chapter 12 - DMS STANDARD METHOD OF SPACE MEASUREMENT.....12-1

Chapter 13 – PROTEST.....13-1

Chapter 14 - GLOSSARY OF TERMS.....14-1

Chapter 15 - OFFICE SPACES STANDARDS AND GUIDELINES.....15-1

Chapter 16 - OFFICE CONSTRUCTION STANDARDS AND GUIDELINES.....16-1

## Chapter 1

## General

## Department Policy, Florida Statutes and Florida Administrative Code

- The Assistant Secretary of Administration is the only delegated authority to sign lease documents.
- Regional General Services Manager shall provide management administration and support services in the area of general services.
- Headquarters General Services will provide technical assistance to the Regions and oversee the entire lease process from initial approval, procurement, and execution of documents.
- Region General Services Manager is custodian of records for all the leases within its region.
- Department of Management Services is responsible for maintaining files of all state leases.
- The availability of DMS owned space within the same geographic region, must be ascertained by DMS. Justification for non-suitability of available DMS-owned space must be provided and must be in accordance with statutory requirements of Section 255.25(4), Florida Statutes.
- A Certificate of Compliance, Form FM 4113, must be filed with the Department of Management Services, for all lease actions in a private or public owned building.
- The Department of Management Services, under the Appropriations Act, may approve a lease purchase, sale-leaseback or tax-exempt leveraged lease contract (Section 255.25(b), Florida Statutes). Contact office of general services support for these special leasing procedures.
- In accordance with 267.061, Florida Statutes, and to assist agencies in the required notification to the division of historic resources, the Department of Management Services bureau of real property management will transmit a copy of any approved Request for Prior Approval of Space Need, RSN to that division. The division will identify any available historic properties suitable for lease by the department. This action by the bureau of property management should not in any way be construed as preempting the necessity for office of general services to notify the division of historic resources.
  - The Regions should include a statement in their advertisement for space being competitively procure that "Historic properties will be considered pursuant to Section 267.061, Florida Statutes."
- Section 403.714, Florida Statutes, mandates that each agency shall have a resource recovery (recycling) program in effect for all space occupied, including private sector lease space. The state is required by law to collect high grade office paper, aluminum and corrugated boxes.
- Special 120-day leases or leases for no consideration do not require prior approval.

- Any lease having a term of less than 120 consecutive days secured for one-time special use, is exempt from the procedures described in this manual (FS 255.25(h)(7). "Special Use" includes short term training, conference or meeting space, or space necessitated by a grant or special appropriation for three months or less. Standard office space required due to poor planning or to relieve short term overcrowding is not acceptable.
- When all efforts (minimum of two prior solicitations) to obtain existing leased space are exhausted, a turnkey (lease) construction program may be necessary to fulfill the space need. The office of general services (ASGGS) will provide individual guidance to those Regions that elect to pursue this program. Preliminary information can be found in Section 60H-1.017, Florida Administrative Code and in the Department of Management Services' Real Property Lease Manual.
- Escalation clauses such as the Consumer Price Index are unenforceable. Specific increases are to be noted for each year in the lease.
- All private sector or publicly owned buildings shall comply with NFPA 101 and the State Fire Marshal standards. Proposed lease construction plans require fire marshal compliance prior to commencement of work.
  - The Department of Management Services will withhold the lease approval until fire marshal compliance is obtained.
- The Regional office has the responsibility for assuring that provisions of Title II, Americans with Disabilities Act, are met in both State owned and State leased space.
- The Right to Terminate clause is mandatory for leases exceeding one year. Leases are generally terminated for one of the following reasons:
  - Availability of Funds. Article 18 of the Standard Lease Agreement addresses the availability of funds appropriated annually by the Legislature for lease purposes and/or the availability of funds through contract or grant programs. Section 255.2502, Florida Statutes.
  - Space in a state-owned facility becomes available. The lessor must be given 6 months' notice for termination of a lease based on state-owned space becoming available as specified in the lease agreement under Article 21.
- To accomplish a successful procurement of a state-owned or private sector lease the Regional office must have:
  - Knowledge of the program(s) requiring space.
  - Definition of the boundaries of the geographic service areas must be based upon the demographics of clients to be served and direction of growth for population.
  - Knowledge of the number of staffs to be housed, number of clients to be served, approved budget dollars, operational time and constraints, anticipated duration of the program and program functional relationships.
  - An outline of specifications considering the number of staffs to be housed, the client population, telecommunication requirements, security needs, amenities, and type of



interior construction within the management initiative of 180 square feet per FTE.  
Section 255.25(3)(h)(7)(a).

- Department's policy limits the procurement of a private sector lease space to a maximum of five (5) years, any negotiation requiring more than a five-year term will require approval from the Assistant Secretary for Administration or designee.
- A business case must be submitted with the cost avoidance for management approval.
- Renewal options cannot be exercised unless at least three (3) years of the base lease term has been completed and the term can't exceed five (5) years.
- Regional office determines and justifies functional space need, prepares all required documentation, and procures the "lowest and best" lease space in accordance with leasing procedures and market conditions.
- The department's policy is to avoid introducing properties into its lease inventory, which are in violation of federal and state environmental laws and regulations.
- Owners of private sector leases must attest that the property has not been a site for hazardous waste operations and that applicable laws have been complied.
  - Any misrepresentation from the lessor will give the Department the right to take necessary action to mitigate the hazard in accordance with all applicable laws or terminate the lease.
- Use of DCF Lease Space by Non-Profit Organizations, such use must be in accordance with the Department of Management Services (DMS) guideline "Soliciting, Access to and Use of State Facilities" (reference: July 1993). Any use of the Department of Children and Families lease space by non-profit organizations should be handled through written communications with the Department of Management Services.
  - If the user is a contract provider wherein the department is required to provide space, such as meeting rooms or conference rooms and office space, reimbursement will be in compliance with contract provisions, or if not stipulated therein, with agreed upon rates for security and utilities.
  - If the user is a non-employee and non-provider, use is permitted only if there is a strong public need (local social services) and only if the region/central office has a policy approved by the office of labor relations (the Department of Management Services) to allow general public use. Reimbursement of utility and security costs as well as a signed statement of department release of liability is required. The bureau of property management has authority to lease all or any portion of a facility to an agency or political subdivision.
  - **IMPORTANT:** If the user is a For Profit Organization, the user should pay sales tax on the sublease space. It is the department responsibility to collect the rental taxes. Region must contact the Department of Revenue for details.

- When alterations are required in private sector leases after occupancy, it is very IMPORTANT remember that:
- The building belongs to the lessor. The cost of all modifications or renovations made for the purpose of bringing leased property into compliance with the uniform fire safety standards shall be borne by the lessor.
- In the event that the department has a need to use State funds to improve a private property, the department shall include in its standard contract document a requirement that any state funds provided for the capital improvements to real property are contingent upon the lessor contractor or political subdivision granting to the state a security interest in the property at least to the amount of the state funds provided for at least 5 years from the date of completion of the improvements or as further required by law. Section 287.05805

### Understanding of the 3 Types of Commercial Real Estate Leases

Commercial real estate leases are complex documents, but they can be understood when you have some background about the terminology associated with them. The types of leases commonly used in commercial real estate is a good starting point, as understanding what each of them involves can help you determine which type will be the best fit for your business needs. The three types of leases are:

- Gross Lease

Also known as a full service lease, a gross lease includes all of the operating expenses for a property, such as the utilities, maintenance and property taxes; DCF only negotiate gross leases.

- A. The upside of these leases is that you are only responsible for paying for one cost. Rent will also remain the same throughout the year, even if you have an unseasonably hot summer that means extra cooling costs or a bitterly cold winter that results in the heating system working overtime.
  - B. On the downside, the base rent will be much higher with this type of lease. Bear in mind landlords may try to add language to the lease that allows for increases in rent if certain events occur like a steep increase in property taxes or insurance premiums.
- Net Lease. With a net lease, base rent is lower, but costs are highly variable. There are three kinds of net leases that you need to be aware of:
    - A. Single Net Lease. This type of lease requires you to pay a fixed rent and a portion of the property tax to your landlord and for utilities and services directly to providers. The landlord covers the costs of building expenses only.
    - B. Double Net Lease. This type of lease is identical to a single net lease, except you are required to also pay a portion of the property taxes, leaving the landlord responsible only for the cost of maintaining common areas.
    - C. Triple Net Lease. With this type of lease, you are expected to pay for a portion of all of the costs associated with double net leases plus a portion of the costs of maintaining common areas. This is one of the most common types of commercial real estate leases.

Net leases tend to favor landlords more than tenants; however, with this type of lease, you can have the ability to demand to review your landlord's costs. If your landlord receives a lower tax assessment and property taxes and insurance rates drop, the savings are passed along to you and other tenants. Keep in mind with this type of lease, costs are unpredictable.

- Modified Gross Lease

Also known as a modified net lease, you are assessed a fixed base rent and then a portion of operating expense costs. The way that these costs are shared and calculated will vary from lease to lease. These leases are an excellent compromise, as they can be favorable for both landlords and tenants. The main drawback to this type of lease is that negotiations will be lengthier and more complex. If you are hoping for a modified gross lease agreement, you should begin your search for office space early to ensure you have enough time to complete the process.

- The Department has 20 Circuits, 6 Regions and Central Office.
- Those Circuit/Regions are as follows:

## REGION DISTRIBUTION

NORTHWEST REGION					
Circuit 1		Circuit 2		Circuit 14	
Escambia	Okaloosa	Gadsden	Jefferson	Bay	Calhoun
Santa Rosa		Franklin	Leon	Gulf	Holmes
Walton		Liberty	Wakula	Jackson	Washington

NORTHEAST REGION							
Circuit 3		Circuit 4		Circuit 7		Circuit 8	
Columbia	Dixie	Duval	Clay	Flagler	Putman	Alachua	Baker
Hamilton	Lafayette					Bradford	Gilchrist
Madison	Taylor	Nassau		St. Johns	Volusia	Levy	Union
Suwanee							

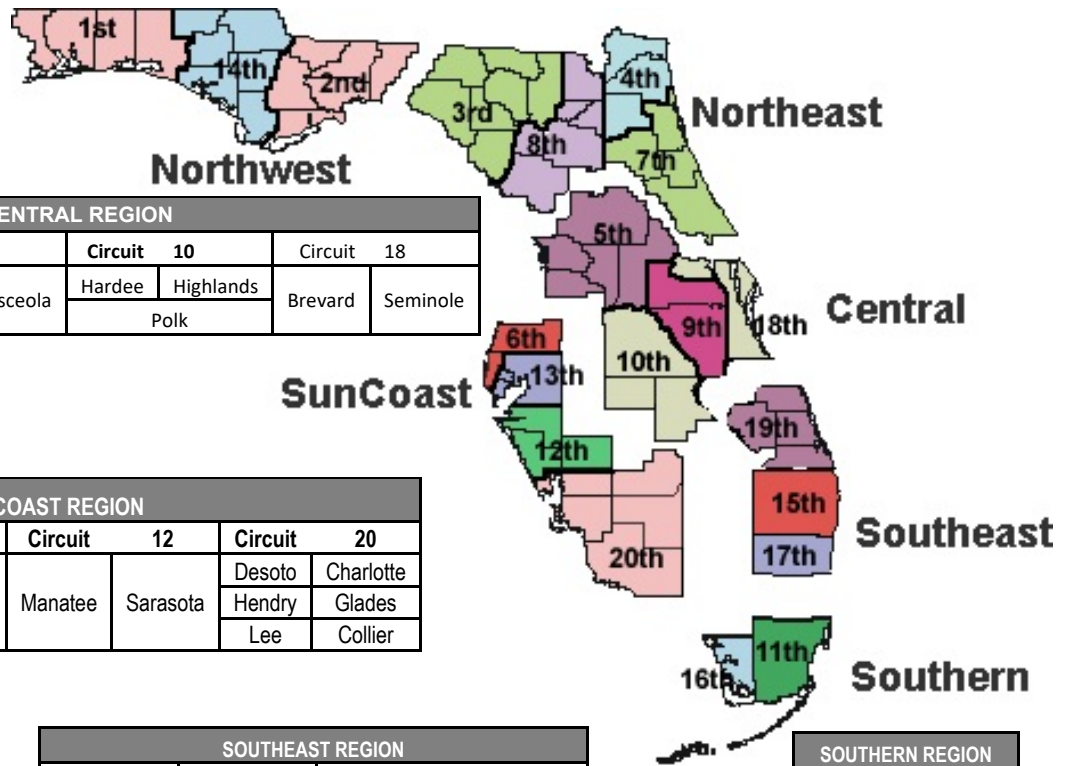

CENTRAL REGION							
Circuit 5		Circuit 9		Circuit 10		Circuit 18	
Citrus	Hernando	Orange	Osceola	Hardee	Highlands	Brevard	Seminole
Lake	Marion			Polk			

SUNCOAST REGION							
Circuit 6		Circuit 13		Circuit 12		Circuit 20	
Pasco	Pinellas	Hillsborough	Manatee	Sarasota	Desoto	Charlotte	
					Hendry	Glades	
					Lee	Collier	

SOUTHEAST REGION					
Circuit 15		Circuit 17		Circuit 19	
Broward		Palm Beach		Indian River	Martin
				Okeechobee	St. Lucy

SOUTHERN REGION	
Circuit 11	Circuit 16
Dade	Monroe

## leasing approval process

- Responsibilities:
  - Agency: Determine and justify space need and procure the most cost-effective space in accordance with the statutes and the procedures set forth in this manual. Prepare leases and related documents.
  - DMS provide authorization to solicit competitive procurement for leased space, review and approve leases.
- Circuit/Region identifies space needs or lease action.
- Circuit/Region prepares a Space Allocation Worksheet (SAW) and a Department Request for Space Need (DRSN), send it electronically to Central Office General Services for the Assistant Secretary of Administration approval.
- General Services review data and forward in electronically to the Assistant Secretary for approval.
- Central Office prepares and sends an electronic Request for Space Needs (RSN) to the Department of Management Services (DMS) for approval after the Assistant Secretary approves the DRSN.
- The DMS approved RSN is forwarded to the Region General Services.
- Regional Facilities Services Manager starts lease process or procurement.
- All proposals for any lease action must be presented to Central Office and the Assistant Secretary of Administration for approval prior to any commitment.
- All lease documents must be sent to DMS and Management for review and pre-approval. Management pre-approval is obtained via Memo Tracker prior to being presented to the Lessor.
- Once DMS and Management approves documents, the Region will forward approved documents to the Lessor for signature.
- After the documents are signed by the Lessor, documents should be signed by the General Legal Counsel and Assistant Secretary of Administration.
- Executed documents must be sent to DMS for final approval.
- Central Office General Services forward executed documents to DMS for final approval.
- DMS send approved documents to the Region and Central Office.
- Lease action completed.

Statutes, Rules and Regulation are applicable in the procurement of leased space:

- Section 20, Florida Statutes. Organizational structure of the various agencies of state government.
- Chapter 83, Florida Statutes. Landlord and Tenant Act.
- Chapter 120, Florida Statutes. Administrative Procedures Act.
- Chapter 253, Florida Statutes. Public Lands and Property.
- Chapter 255, Florida Statutes. Public Property and Publicly Owned Buildings.
- Section 267.061, Florida Statutes. State policy on utilization of state historical properties.
- Section 267.061, Florida Statutes. Resource Recovery (Recycling) Program.
- Chapter 4A-3, Florida Administrative Code. Fire Prevention, General Provisions.
- Chapter 10-22, Florida Administrative Code. Utilization of Minority Business Enterprises.
- Chapter 60D-4, Florida Administrative Code. Rules for construction and leasing of state buildings to ensure energy conservation.
- Chapter 60D-5, Florida Administrative Code. Procedures for construction, contract bidding and award and contract award negotiation.
- Chapter 60D-7, Florida Administrative Code. Minimum codes for state construction under the jurisdiction of DMS.
- Chapter 60D-10, Florida Administrative Code. Public Facilities Conversion.
- Chapter 60D-11, Florida Administrative Code. Procedures and requirements of Alternate Energy and Life Cycle Cost Analysis Programs for state-owned and leased Facilities.
- Chapter 60D-12, Florida Administrative Code. Physical and operational security for state-owned computer rooms.
- Chapter 60H-1, Florida Administrative Code. Leasing rules for real property.
- Chapter 60H-2, Florida Administrative Code. Space allocations in state-owned buildings.
- Chapter 60H-4, Florida Administrative Code. Parking.
- Chapter 60H-5, Florida Administrative Code. Smoking policies in state office buildings.
- Chapter 60H-6, Florida Administrative Code. Use of state office buildings.
- Chapter 60H-7, Florida Administrative Code. Florida facilities pool.
- Chapter 60H-8, Florida Administrative Code. Flags at half-mast.

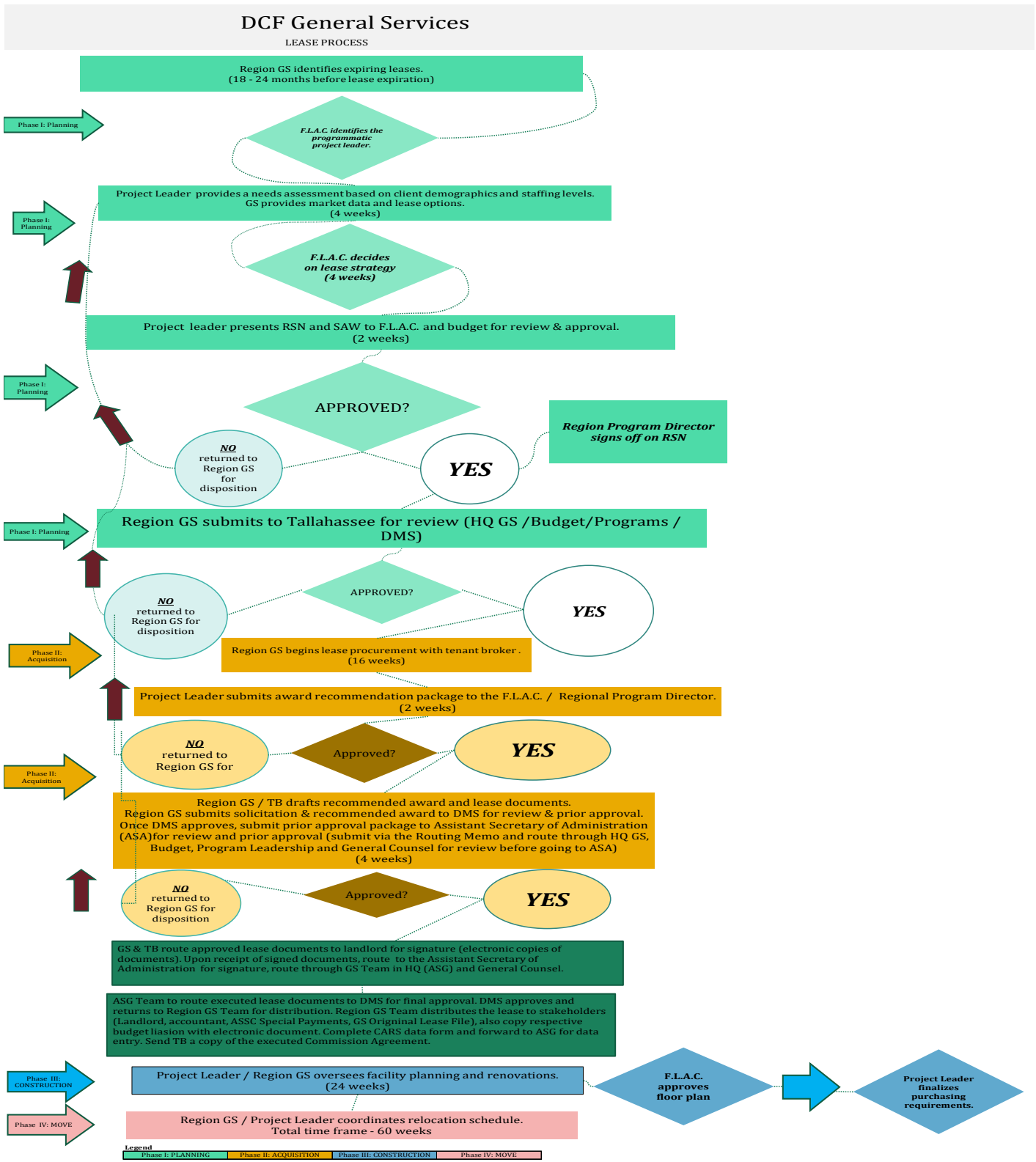

## Chapter 3

## Certifying space needs

Commercial markets are described as a “landlord market” in a booming economy or a “tenant market” in a regressed economy. Leasing decisions are certainly affected by the amount of available space and the choices available to the parties and it will vary depending on the economic environment. But the process will always it remains constant.

To accomplish a successful procurement, you must have:

- Knowledge of the number of employees needed to be housed, number of clients to be served, approved budget dollars, operational time and constraints, anticipated duration of the program and program functional relationships. A Program Space Needs Worksheet, must be prepared, by contacting the program and request the following information:
- Request a detailed number of FTEs by classification. (Supervisors, Clerical, Paraprofessional, OPS), to be housed in the leased space.
  - Number of Hoteling and staff frequency in office
  - Number of Telecommuter and staff frequency in office
  - Number of transition staff
  - Number of OPS
  - Number of people per training room and frequency
  - Number people per conference room and frequency
  - Number of clients visit per day.
    - Clients per hour?
    - Client turns over time?
- Boundaries for the geographic service areas must be based upon the demographics of clients to be served and direction of growth for population.
- A graphical client representation on a heatmap or scatter map that it will assist in:
  - Identifying potential commercial sites available
  - Assessing neighborhoods quality
  - Direction for the client growth
  - Locations and nearby amenities
  - Information to develop an Independent Market Analysis (IMA)
  - Get an average price and projected cost.
  - Locations analysis and comparison
  - Client accessibility
  - Public transportation availability
- Location – Make sure that the property is either around your ideal customer or ideal workforce. Also, you’ll want to find a space that has adequate **foot traffic** and vehicle traffic as well as adequate parking for customers or employees.
- Amenities and Services – You’ll want to understand the full range of amenities offered by commercial space. These amenities and services may include such things as communal rooms, free Wi-Fi, dining options, outdoor space, and more.



- Knowledge of the program(s) needs.
  - Clients service areas
  - Training rooms and number of users
  - Storage areas
  - Children areas
  - Interview rooms
  - Visitation rooms
  - Conference areas
  - Parking
  - Working schedule
  - Security
- Programs must complete the following Program Request Form to identify and calculate the required space needs by:
  - Identifying the Hotelers and Telecommuters and how frequent they visit the office.
  - Identifying the number of clients per day and the average turn over time.
- After completing the Program Request Form, we prepare the DMS Space Allocation Worksheet.

PROGRAMS SPACE NEEDS WORKSHEET						
Contact Person:		Phone #:				
Email		CITY:				
CURRENT LEASE #:		COUNTY:				
Proposed Term From:		Current FTE's:		0		
Option Years:		Current Sq./Ft:				
Current Rate:		Projected New Rate:				
Current Annual Cost:	\$0.00	Projected Annual Cost:		\$0.00		
PERSONNEL AREA						
POSITION	ADM	SAMH	IT	FAMILY SAFETY	ACCESS	TOTAL
Supervisors						0
Professionals						0
Para-Professionals						0
OPS/Interns						0
Hotellers <i>frequency in office</i>						0
Telecommuter <i>frequency in office</i>						0
<b>TOTAL</b>	0	0	0	0	0	0
SUPPORT AREA						
<i>Average clients day</i>						0
<i>Average Clients per hour?</i>						
<i>Average Client turn over?</i>						
Copy Machines/Scanners						0
Open Records File Cabinets						0
Storage						0
Mail processing equipment						0
Conference Room (10-12 Person)						0
Conference Room (6-8 Person)						0
Conference Room (2-4 Person)						0
<i>Training room</i>						0
<i>Average person /training frequency of training</i>						
Interview Rooms						0
Children Supply Storage						0
Play/Visitation Rooms						0
Service counter Client / Hour						0
Number Web/App Stations						0
Phone Booth						0
Care Coordinator room						0
<i>Average Client /day</i>						
Certifying						
<b>The undersigned hereby certifies that the space criteria follows DCF standards and this request doesn't provides excess space to this unit of State Government.</b>						
<b>NAME</b>				<b>DATE</b>		
<b>SIGNATURE</b>						

- On March 24, 1970, the governor and cabinet adopted the state facilities management program. This program was revised by Legislature in 2008 and provided a systematic plan for making space allocations to staff and support space in all state-occupied facilities. Using established guidelines of the management program, a proposed facility may be calculated by the square footage allocated by job functions. Unusual client service requirements may allocate additional square feet.
- Effective May 2008, under Florida Statute 255.25(h) (7) (a) the goal of the workspace-management initiative is 180 square feet per FTE. The 180 square feet is inclusive for active storage, reception, conference, library, general storage, machine room, machine room circulation space, etc. Additional square footage is allowed for client service areas.
- A Space Allocation Worksheet (SAW) was designed to assist the agency in determining the overall space requirements by calculating total footage based upon space criteria determined by the state facilities management program.
- Space requirements are documented on the Space Allocation Worksheet (SAW) Form 4100. This form is found at:  
[http://www.dms.myflorida.com/business\\_operations/real\\_estate\\_development\\_and\\_management/facilities\\_management/lease\\_management/state\\_agency\\_leasing\\_liaisons/pre\\_approved\\_lease\\_management\\_forms](http://www.dms.myflorida.com/business_operations/real_estate_development_and_management/facilities_management/lease_management/state_agency_leasing_liaisons/pre_approved_lease_management_forms)
- A SAW must be submitted to Central Office with every lease action.
- DMS' uses the SAW to verify the use of the space requested by the agency needs and meets the workspace-management initiative of 180 square feet per FTE.
- Central Office submits to DMS the SAW with the Request for Space Needs (RSN) electronically in TRIRIGA, (<https://flfacmgt.myflorida.com/login>).

This is the initial lease document for any type of lease action that it is required.

**SPACE ALLOCATION WORKSHEET (SAW)  
INSTRUCTIONS**

This document is designed to assist your agency in documenting both current and future personnel/space requirements. This Introduction explains the information included in each subsequent Workbook Tab and provides guidelines for completing the DMS Space Allocation Worksheets. The workbook consists of 18 workbook tabs as described below.

Tab 1: Introduction - Provides Introduction and Instructions for use of the Space Allocation Worksheet.

Tab 2: Summary - Summary of Agency Requirements from Division and Special Use tabs, and worksheet for determination of standard support area requirements.

Tab 3: Special Use Tab - Worksheet for use in identifying any requirements for special use support areas.

Tabs 4 – 13: Div. 1 through 10 Tabs - Worksheet for use in entering personnel requirements by division.

Tab 14: DMS Space Standards - Description of the five (5) DMS office/workstation space standards by job title and job function. Included for information and reference to worksheet user.

Tab 15: Prototype Plan - Illustration of a prototypical office layout utilizing the DMS space standards and a 20% enclosed office/80% open workstation ratio. The plan also illustrates the size and capacity of the space standards, the use of interior offices, and the size and type of standard support spaces. Included for information and reference to worksheet user.

Tabs 16-18: Sample Program Tabs - The last three (3) tabs of the workbook include sample programs for a 25-Person agency, a 60-Person agency and a 200-person agency. The sample programs have been prepared to illustrate only the appropriate ratios of Standard Support Areas, and do not include any Special Support Areas, as these are specific to each agency, and are not included in the DMS 180 USF/employee efficiency target.

#### WHERE TO ENTER INFORMATION

To complete the Worksheets, you only need to enter information into spaces that are color-coded as follows.

Light Blue Area - Agency Information – This section of the worksheet provides contact details for the agency. Complete all blocks as required

Yellow Area - Requirements - Enter personnel, special support space and standard support space requirements into these blocks

USING THE DMS SPACE ALLOCATION WORKSHEET

Prior to entering data into the worksheet review the instructions and familiarize yourself with the DMS Space Standards. Confirm your agency organization, personnel headcounts by division, and any special support requirements. Also confirm that personnel can be allocated by the existing DMS space standards and identify any requirements that do not comply. Complete the worksheets in the following order.

Step 1: Agency Information. Complete all requested agency Information in the blue box at the top of the worksheets in the Summary, Special Use and Division tabs.

Step 2: Division 1 - 10 Tabs. Enter personnel requirements by division. There are 10 division tabs, although most agencies will be smaller. For agencies with multiple divisions, use one tab for each division. For agencies that do not have multiple divisions, or for very small requirements (40 persons or under), enter personnel data only in the Division 1 tab. Complete each division worksheet using the (5) five DMS Workplace Standards indicated on the worksheet (and included in the 'Space Standards' Tab of the workbook). If additional office or workstation types are required, please add these in the rows provided, and include a description of these requirements in the Notes section of the worksheet.

Step 3: Special Support Tab. Enter all Special Support spaces that are required by your agency. Special Support spaces include both 'Public Use' space (areas that are specifically required by an agency to serve and/or accommodate public visitors, clients or service users) and Special Use spaces (areas that are specifically required to support the agency's mission or operations and are required to supplement the Standard Support Areas included in the 'Summary' Tab Worksheet). Public Use includes spaces such as service counters, file rooms, interview rooms, etc., and Special Use includes spaces such as conference/training centers, labs or special workrooms. We have included a list of some of these space types as a guideline.

Step 4: Summary Tab. Upon completion of Steps 1 and 2, return to the 'Summary' Tab. Division personnel requirements will have been automatically tabulated. The total agency personnel will appear on Line 30 and the total Useable Square Feet of space required for personnel will appear on line 31. The total Useable Square Feet of special spaces required will appear on Line 51.

Based on the agency personnel total (Line 30), and utilizing the metrics provided (for example, 1 storage closet per 40 employees), enter the standard support space requirements on Lines 34 - 44. These will be different for each agency, depending on total personnel headcount. Round up or down as required (based on the number being above or below 50% of the metric). The total number of agency personnel should be divided by the number indicated for each type of space. Refer to the examples below for the typical space tabulations for both a large (200 person) and small (60 or below person) agency.

200 Persons:			60 Persons or Below:		
Reception		1	Reception		1
LAN Room		1	LAN Room		1
Open Files		100 Files	Open Files (60 person)		30 Files
Storage		5	Storage		2
Pantry/Copy		3 Each	Pantry/Copy		1 Each
Conference (10-12)		2 Each	Conference (10-12)		1
Conference (Other)		5 Each	Conference (6-8)		1
			Conference (2-4)		1
			Open Team Area		2

Note: For agencies of 60 persons or smaller, assume agency gets a minimum of 1 Reception, 1 Lan Room, 1 Pantry and 1 Copy (these may be combined for 40 persons or smaller), and 1 each of conference and meeting rooms (groups smaller than 40 persons also may not require a 350 SF Conference Room).

Completed Worksheet. Once Step 3 is complete, refer to the section of the worksheet titled 'Total Agency Area Requirements,' which summarizes the following items.

- **Sub-total Usable Area SF** (total Personnel Area + the Total Support Area + a 35% circulation factor). This tabulation is automatic and should not be altered by the worksheet user.
- **Usable SF/Employee** (Sub-total Usable Area / Total Personnel). This tabulation should average to 180 SF/person.
- **Total Usable Area SF** (Adds the Sub-total Usable Area + the Special Support Area). This tabulation is automatic.
- **Total Usable Square Feet/Employee** (Total Usable Area/Total Personnel). This tabulation is automatic.



**STATE OF FLORIDA**  
**DEPARTMENT OF MANAGEMENT SERVICES**  
**SPACE ALLOCATION WORKSHEET**

**AGENCY REQUIREMENTS SUMMARY**

<b>AGENCY INFORMATION</b>									
Agency Name:	Example Agency				Contact Person:	Example Contact			
Location:	Example Location				Telephone:	850-555-5555			
Building:	Example Building				Email:	Example @myflorida.com			
Lease No:	Example Lease No				Date:	1/1/09	Revised:	1/1/2009	
<b>AGENCY SPACE NEEDS</b>					<b>Current Space Needs</b>			<b>Future Space Needs</b>	
Personnel Areas		Typical Size SF	x	No.	= Area	No.	= Area		
Type A	Enclosed Office <i>window office</i>	Executive	225	x	0	0	0	0	0
Type B	Enclosed Office <i>window or interior office</i>	Administrator	150	x	0	0	0	0	0
Type C	Enclosed Office <i>interior office</i>	Manager & Professional Requiring Confidentiality	100	x	0	0	0	0	0
Type D	Workstation	Professionals & Supervising Professionals	80	x	0	0	0	0	0
Type E	Workstation	ParaProfessional	60	x	0	0	0	0	0
				x	0	0	0	0	0
				x	0	0	0	0	0
<b>Total Personnel</b>					<b>0</b>	<b>0</b>	<b>0</b>	<b>0</b>	<b>0</b>
<b>Total Personnel Area SF</b>					<b>0</b>	<b>0</b>	<b>0</b>	<b>0</b>	<b>0</b>
Standard Support Areas		Typical Size SF	x	No.	= Area	No.	= Area		
<b>General Support</b>									
	Reception	1 per Suite or Floor	200	x	0	0	0	0	0
	LAN Room	1 per Suite or Floor	75	x	0	0	0	0	0
	Open Files	6 lin.ft./person/12lin.ft./file	9	x	0	0	0	0	0
	Storage	1 per 40 employees	100	x	0	0	0	0	0
	Pantry	1 per 60 employees	200	x	0	0	0	0	0
	Copy	1 per 60 employees	200	x	0	0	0	0	0
<b>Conference/Meetings</b>									
	Conference Room (10-12 Person)	1 per 80 employees	350	x	0	0	0	0	0
	Conference Room (6-8 Person)	1 per 40 employees	250	x	0	0	0	0	0
	Conference Room (2-4 Person)	1 per 40 employees	100	x	0	0	0	0	0
	Open Team Work Area	1 per 40 employees	100	x	0	0	0	0	0
<b>Total Support Area SF</b>					<b>0</b>	<b>0</b>	<b>0</b>	<b>0</b>	<b>0</b>
<b>Total Agency Area Requirements</b>									
<i>Net Usable Area (Sum of Personnel and Support Areas)</i>						0			0
<i>Circulation (35% of net usable area)</i>						0			0
<b>Sub-Total Usable Area SF</b>						<b>0</b>			<b>0</b>
<b>Usable Square Feet/Employee (180 USF/FTE Average Target)</b>						<b>#DIV/0!</b>			<b>#DIV/0!</b>
<i>Total Special Support Area (From Page 2 Worksheet)</i>						0			0
<b>Total Useable Area SF</b>						<b>0</b>			<b>0</b>
<b>Total Useable Square Feet/Employee</b>						<b>#DIV/0!</b>			<b>#DIV/0!</b>



**STATE OF FLORIDA**  
**DEPARTMENT OF MANAGEMENT SERVICES**  
**SPACE ALLOCATION WORKSHEET**

**AGENCY SPECIAL SUPPORT REQUIREMENTS**

<b>AGENCY INFORMATION</b>							
Agency Name:	Example Agency	Contact Person:	Example Contact				
Location:	Example Location	Telephone:	850-555-5555				
Building:	Example Building	Email:	Example @myflorida.com				
Lease No:	Example Lease No	Date:	1/1/09	Revised:	1/1/2009		
Public Use Space		Size SF	x	No.	= Area	Current Space Needs	Future Space Needs
						No.	= Area
Main Reception Area		0	x			0	
Service Counter/Waiting Area		0	x			0	
Interview Rooms		0	x			0	
Court/Hearing Rooms		0	x			0	
		0	x			0	
		0	x			0	
		0	x			0	
		0	x			0	
		0	x			0	
		0	x			0	
<b>Total Public Use Space</b>		<b>0</b>				<b>0</b>	<b>0</b>
Special Use Space		Size SF	x	No.	= Area	No.	= Area
Security Facilities		0	x			0	
Mail Room		0	x			0	
Records Storage		0	x			0	
Central Document Storage and/or Processing		0	x			0	
Copy/Repro Center		0	x			0	
Conference Center		0	x			0	
Training Center		0	x			0	
Auditorium		0	x			0	
Library		0	x			0	
Cafeteria		0	x			0	
Fitness		0	x			0	
Daycare		0	x			0	
Medical Facilities		0	x			0	
Drug Labs		0	x			0	
Data/Computer Center		0	x			0	
IT Storage/Receiving/Workrooms		0	x			0	
Supply/Warehouse Facilities		0	x			0	
		0	x			0	
		0	x			0	
		0	x			0	
<b>Total Special Use Space</b>		<b>0</b>				<b>0</b>	<b>0</b>
<i>Net Usable Area (Special Support Areas)</i>						0	
<i>Circulation 30% of net usable area</i>						0	
<b>Total Usable Special Support Area Required</b>						<b>0</b>	<b>0</b>





**STATE OF FLORIDA**  
**DEPARTMENT OF MANAGEMENT SERVICES**  
**SPACE ALLOCATION WORKSHEET**

**AGENCY DIVISION SUMMARY**

<b>DIVISION INFORMATION</b>									
<b>Agency Name:</b>	Example Agency			<b>Dept. Contact:</b>	Example Contact				
<b>Division:</b>				<b>Telephone:</b>	850-555-5555				
				<b>Email:</b>	Example @myflorida.com				
				<b>Date:</b>	1/1/09	<b>Revised:</b>	1/1/2009		
<b>DIVISION SPACE NEEDS</b>									
Personnel Areas				Current Space Needs			Future Space Needs		
			Typical Size SF	x	No.	= Area	No.	= Area	
Type A	Enclosed Office <i>window office</i>	Executive	225	x		0		0	
Type B	Enclosed Office <i>window or interior office</i>	Administrator	150	x		0		0	
Type C	Enclosed Office <i>interior office</i>	Manager & Professional Requiring Confidentiality	100	x		0		0	
Type D	Workstation	Professionals & Supervising Professionals	80	x		0		0	
Type E	Workstation	ParaProfessional	60	x		0		0	
				x		0		0	
				x		0		0	
<b>Total Personnel</b>					<b>0</b>		<b>0</b>		
<b>Total Personnel Area</b>						<b>0</b>		<b>0</b>	
<b>NOTES</b>									

## DEPARTMENT REQUEST FOR SPACE NEED, (DRSN)

The second document needed to initiate a lease action is the DRSN that outlines the budget impact.

- A prior approval from the Assistant Secretary of Administration is require for any lease action.
- The DRSN approval from the Assistant Secretary of Administration requires that:
  - Regional Program certifies that the request meets the department lease and budget plans.
  - HQ Program Director or designee certifies that the lease action meets the space criteria standards.
  - HQ Budget verify and certify the availability of funds.
  - ASG verifies the request information and makes recommendation.
- Questions if region has significantly changed their leasing plans and why.
  - Is this request on the Region's Lease Plan at HQ?
  - Is it significantly different in size, cost or staffing from the Lease Plan?
  - Is this a stay in place request, option renewal or new lease location?
  - Is this a gross lease? If not, what is the per SQ FT estimate of these services?
  - How does the estimated or proposed SQ FT rate compare with the market rate?
  - Is there a significant build out included in the estimate?
  - What is the term of the lease and options?
  - What programs are in the lease request?
  - Is any of leased space subleased to other entity? If yes, how much?
  - What would the region have to do if this request is denied?
- Questions to test to see if Region is employing hoteling or telecommuting.
  - Does the region indicate on DRSN that Hoteling is planned for location?
  - Is the average SQ FT per FTE = or < 180? If not, why?
  - Cost per FTE is justifiable.
  - Does lease include APIs or CPIS, Hoteling or telecommuting?
  - Is this request a reduction in space and total cost?
  - Does this request reduce the average SQ FT per FTE?
  - If ACCESS program, does it include both storefront and/or backroom staff?
  - Is telecommuting of ACCESS backroom employed?
  - Is any of lease space proposed for sublease to others? How much and to who?
  - Is this request for a new service location without another location closing?
  - Is this request part of the lease plan involving more than one location?
  - Where are the nearest current lease locations to this request?
- Questions to answer to test whether state owned space is maximized.
  - Is there any DMS or DCF owned buildings in the same county or metropolitan area as lease?
  - Is the DMS or DCF owned building space currently maximized or could it absorb FTEs from the lease location?

## DEPARTMENT REQUEST FOR SPACE NEED (DRSN) INSTRUCTIONS

1. REGION: Enter region name.
2. LEASE NO.: Enter current lease number for Modification; if new lease leave it blank (Number is assigned by DMS).
3. CIRCUIT: Enter the circuit number.
4. CITY: Enter the name of the city in which the space is needed.
5. COUNTY: Enter the name of the county in which the space is needed.
6. TYPE LEASE ACTION: Enter appropriate action (Mark if: New lease or Modification).
7. TYPE OF SOLICITATION: Enter how the procurement will be done. (Quote, ITB, RFP, ITN, SIP, etc.)
8. BROKER TO BE USED: Identify if a Tenant Broke is being used and who,
9. JUSTIFICATION: Explanation using Tenant Broker if not considered.
10. PROPOSED TERM: Enter the proposed starting and ending date of lease.
11. TOTAL LEASE TERM: Enter the number of years being requested.
12. RENEWAL OPTION: Enter the number of options and length of option term.
13. PROGRAM OFFICE TYPE: Enter the programs name being house in this facility.
14. IMPLEMENTING HOTELING: Enter Yes or Not, if hoteling is being used.
15. CURRENT LEASE NUMBER: Enter current number of the existing lease.
16. CURRENT SQUARE FEET: Enter current square feet of the existing lease.
17. CURRENT RATE PER SQUARE FEET: Enter current rate per square feet.
18. CURRENT LEASE FTE's: Enter current number of FTEs in the existing lease.
19. CURRENT LEASE ESCALATION PERCENT: Enter the percentage.
20. PROPOSED REQUESTED SQUARE FEET: Enter the number of square feet you are requesting.
21. PROJECTED NEW LEASE RATE: Enter the projected market rate.
22. TOTAL SQUARE FEET JUSTIFIED: Enter total square feet justified in the SAW (Form 4100).
23. PROPOSED ADMINISTRATIVE SQUARE FEET PER FTE's: Total Useable Square Feet/Employee from the SAW
24. PROPOSED NEW NUMBER OF FTE's: Enter number of FTEs in new SAW (Form 4100).
25. PROJECTED LEASE ESCALATION PERCENT: Enter the percentage.

26. IF TOTAL SQUARE FEET IS GRATER THAN 180: Enter a justification of why is grater than 180
27. ADDITIONAL COMMENTS: Enter appropriate information of the lease action being requested.
28. NEW LEASE BOUNDARIES: Enter the boundaries for client service area.
  
29. REGIONAL PROGRAM APPROVAL: Certifies that the request meets the Regions budget plans.
30. HQ PROGRAM DIRECTOR SIGNATURE: Certifies adherence to space criteria standards were used to compute space requirements.
31. HQ BUDGET REVIEW APPROVAL: Certifies the availability of funds.

DRSN

Department Request for Space Need Form (DRSN)												
-- All * are required Field --For New Lease provide proposed boundaries and demographic zip code --												
Region*:	1			Lease No*:	590: 2		Circuit*:	3				
City*:	4						County:	5				
Lease action*:	NEW	6	MOD	6	Type of Solicitation*:			7				
Broker Used*:	8				If not used explain*:							9
Lease Term*:	10		10		Total Years*:		11	With an option*:	12	12		
Program Office Type*:	ADM*	13	LEGAL*	13	ACCESS*	13	PI's*	13	API's*	13	Hotel/Telecommute Yes or No*:	14
Current Lease						Proposed Lease						
Lease No*:	590: 15					Requested Sq./Ft*:	20		Projected Rate*:	21		
Sq.Ft.*:	16	Annual Cost:	\$0.00			Total square feet justified*:	22		Total Useable Sq/Ft/FTE's*:	0		
Rate Sq.Ft.*:	17	Monthly Cost:	\$0.00			Administrative Square Feet*:	23		Administrative Sq/Ft/FTE's*:	0		
Current FTE's*:	18	Cost FTE:	\$0.00			New FTE's*:	24		Projected Cost FTE:	\$0.00		
Total Useable Sq/Ft/FTE's*:	0	Current Rate* Escalation %:	19		Projected Rate* Escalation %:	25		Square Feet Difference:	0			
Please Explain: If Total square feet/FTE exceeds 180 SF *												
26												
Lease action justification*:												
27												
Lease Boundaries*:	28											
FISCAL IMPACT												
Projected Annual Cost*:	\$0.00			Projected Term Cost:	\$0.00			Projected Cost Avoidance:	\$0.00			
APPROVAL PROCESS												
The undersigned hereby certifies that the space criteria standards published by the Department of Management Services as a part of the Facilities Management Program have been used to compute the space requirements necessitating this lease and that this request in no way provides excess space to this unit of State Government. <b>Note - attached lease cost comparison sheet.</b>												
ADM	Regional Program*:	29				CO Program Director*:	30					
	Name*:					Name*:						
CLS	Regional Program*:	29				CO Program Director*:	30					
	Name*:					Name*:						
ESS	Regional Program*:	29				CO Program Director*:	30					
	Name*:					Name*:						
CPI	Regional Program*:	29				CO Program Director*:	30					
	Name*:					Name*:						
API	Regional Program*:	29				CO Program Director*:	30					
	Name*:					Name*:						
SAMH	Regional Program*:	29				CO Program Director*:	31					
	Name*:					Name*:						
Budget Review:	Name:	31			Signature:	31			Date:			



## 4. TENANT BROKER

### Proviso Language on Tenant Broker

*“Section 47. In order to implement appropriations used to pay existing lease contracts for private lease space in excess of 2,000 square feet in the General Appropriations Act, the Department of Management Services, with the cooperation of the agencies having the existing lease contracts for office or storage space, shall use tenant broker services to renegotiate or re-procure all private lease agreements for office or storage space.”*

### What Is a Tenant Broker?

A tenant broker is a representative who assist the department to locate suitable commercial property and can provide sound analysis of the real estate market conditions, space availability, and negotiate leases with a landlord on behalf of the department. The use of the Tenant Broker should “add value” to the lease cost.

### What should the Tenant Broker do?

Must provide data on market analysis, space demographic, cost of occupancy, and any other information that can assist you with:

- Deciding whether to procure a new lease or modify existing lease.
- Finding the right space within the client demographics area that will meet the program needs including building quality, amenities, adequate parking, good public transportation and security.

### Difference Between Commercial Brokers vs Tenant Brokers

- Commercial Broker: The commercial broker has a fiduciary obligation to the building owner, and it is legally obligated to represent the owner’s best interest. Their primary responsibility is to get the *highest* lease rates and best terms possible for the building owner. They are not allowed to tell you how low the building owner is willing to go or how badly they need to lease the space.
- Tenant Broker: Tenant brokers must have a fiduciary obligation to the department’s best interest in a lease procurement or negotiations. They must provide to the department any information known to get the lowest lease rates and best terms possible.

### What should you expect from the Tenant Broker?

**A. Pre-Work:** Within first 2 weeks of the RSN lease assignment, the tenant broker will:

- Before any work commences, provide the department a detailed preliminary summary of market analysis and rates of potential sites, number of buildings, building age, tenancy mix, sizes, costs, and location.

- Supply a detailed timeline indicating all project milestones and their completion dates
- Assist the department with boundary limitations in accordance with agency business needs to allowing for the maximum competition.
- Assist with the primary decision criteria for the selection of an “award.”
- Provide a list of all state owned and lease property with within the defined boundaries.
- Provide a written assessment identifying preliminary courses of action for the lease with pro/con assessment and projected cost per occupant of each potential action.
- Review and summarize subject lease action with recommendations in most recently submitted DMS Master Leasing Report and Strategic Leasing Plan.
- Draft, review, and provide recommendations of any lease terms that may vary from approved lease forms (Rule 60H-1.003, F.A.C.).

**B. Lease Procurement Activities:** For each transaction assigned, the tenant broker will:

- Assist the department with the development of the Quote-ITN documents (provide feedback and clarifications in writing prior to release of the proposal), review and provide recommendations on, or draft, procurement documents.
- Distribute procurement documents; assist with tracking who received bid documents or bid modifications; and, if applicable, attend any pre-proposal conferences and assist with any formal conference questions and answers.
- Conduct pre-proposal conferences and proposal openings.
- Provide the department, in writing, an evaluation synopsis of all responsive proposals received that includes, at a minimum, comments on their approach, responsiveness and technical merit of each proposal submission.
- Complete an evaluator tour package, schedule and attend all site walk tours with evaluation team members and the facilities office. This package should include a check list, the tenant broker’s evaluation synopsis, BOMA rating, tenant mix information and any concerns related to the landlord’s financing submittal.
- Provide an updated market rate analysis.
- Provide summary of evaluations and recommended shortlisted proposers.

**C. Formal Lease Negotiation:**

- Serve as “Lead Negotiator” for the top ranked proposals.
- Negotiate with the preferred or shortlisted properties as appropriate.
- Provide a synopsis of negotiation meetings and conversations and submit to the department upon execution of the lease.
- Draft necessary documents as LOI’s and tenant improvements needs.

- Provide to the Department the value of the negotiated lease term minus costs related to tenant improvements.
- Obtain market comparable and value via an Independent Market Analysis (IMA).
- Document and track square footage savings.
- Request the energy efficiency modeling and SFM plan review approvals from the selected provider.
- Coordinate with the Agency and DMS the lease execution, including draft lease.

#### **D. Project Management/Closeout:**

- Provide all correspondence related to the deal.
- Provide documentation indicating the number of brokers contacted for a transaction.
- Provide a complete transaction close out package that, at a minimum, includes copies of the negotiated contract.
- Draft lease documents and any attachments and rout them for signature.
- Coordinate for the Certificate of Occupancy and State Fire Marshal final approvals.
- Work with the Department on the development of space planning with the awarded provider and obtain a detailed construction timeline.
- Ensure that the provider knows that they (the landlord) are responsible for scheduling and attending weekly site construction and walk throughs. Provider must provide written status each week detailing the condition of the construction site noting any deficiencies.
- Provide weekly updates in writing on the status of activities related to a transaction.
- Complete the Tenant Broker survey and return it to the department.
- Follow up with all other proposers that submitted a no bid or extremely high bid to determine process improvement that would have made the deal more attractive. Submit that information to the Department.

#### **Project Measurement Performance Criteria.**

##### Tenant Broker Measurements:

- Was a detailed market analysis received?
- Was a timeline with project milestones and dates received?
- Was an evaluation synopsis of all responses received?
- Was an evaluator tour package completed?
- Were all required meetings attended and were written weekly updates received.
- Were timelines met?



- Was a market comparable via an Independent Market Analysis (IMA) obtained?
- Was documentation on square footage savings obtained?
- Was a complete transaction close out package submitted?
- Was Tenant Broker survey returned to the department?

Facilities Measurement Criteria:

- Were the programs timely notified of an action?
- Did Facilities meet all their timelines?
- Did Facilities attend all meetings?
- Was process survey returned to the department?

Program Measurement Criteria:

- Did the department submit their documentation timely?
- Did the department meet all their timelines?
- Did the department attend all meetings?
- Was process survey returned?

<b>Tenant Broker Engagement Checklist</b>						
<b>Engagement Title:</b>						
<b>Eligible User:</b>						
<b>Tenant Broker:</b>						
The Contractor and the Eligible User shall use this checklist (or other appropriate scope of work) to define and confirm all deliverables, and if the deliverable will be in written form and expected due dates. Eligible Users may add such information to this form as needed.						
<b>LEASE PRE-WORK</b>				<b>Is Required</b>		<b>Date Due</b>
				<b>YES</b>	<b>NO</b>	
1.	Determine/validate desired boundaries against business drivers.					
2.	Determine/validate primary decision criteria for selection of an “award.”					
3.	Present summary of market rates, vacancy and absorption (current and tend) as defined below: a. Scope of summary (e.g., within 5 miles, All class B, etc.) b. Period for trend data c. Additional market information requested					
4.	List all state owned and leased real property with a radius defined here, as reported on publicly available state database and all excess space available. Radius: _____					
5.	Provide a written assessment identifying preliminary courses of action for lease with pro/con assessment and projected cost per occupant of each potential action.					
6.	Review and summarize subject lease action “fit” with recommendations in most recently submitted DMS Master Leasing Report and Strategic Leasing Plan.					
7.	Draft, review, and provide recommendations of any lease terms that may vary from approved lease forms (Rule 60H-1.003, F.A.C.)					
<b>PROCUREMENT</b>						
1.	Review and provide recommendations on, or draft, procurement documents.					
2.	Distribute procurement documents and associated notices as follows:					
3.	Assist the agency in responding to bidders’ questions.					
4.	Participate in bidder conferences/meetings.					
5.	Provide a written synopsis of each bid received to determine its adherence to the bid criteria and assist in the identification of “responsive” bids.					
6.	Create tour evaluation packages for site evaluators and conduct all site tours.					
7.	Provide an updated market rate analysis.					
8.	Serve as “Lead Negotiator” for the top site or site(s).					
9.	Provide updates on negotiation activities and interactions with bidders at following interval(s):					
10.	Provide summary of evaluations and recommended bidder to whom Eligible User should award in accordance with selection criteria.					
11.	Obtain a signed Commission Agreement.					
<b>LEASE EXECUTION</b>						
1.	Review and provide recommendations on, or draft, lease documents.					
2.	Route lease documents to ensure complete execution.					
<b>PROJECT CLOSE OUT</b>						
1.	Conduct lease transaction service close out review with Eligible User using Engagement Checklist to verify/validate completion of all agreed upon services.					

Tenant Broker Evaluation Form

<b>Instructions</b>
<ul style="list-style-type: none"> <li>• First, complete the section titled "<b>Information.</b>"</li> <li>• Next, assign a letter grade of <b>A-F</b> for phase 1-3.</li> <li>• If applicable, assign a letter grade (<b>A-F</b>) for <b>phase 4</b> (build-out).</li> <li>• If applicable, insert any <b>comments</b> in the "<b>comments</b>" section.</li> <li>• Last, <b>print</b> the form sheet, and <b>sign</b> on the signature line at the bottom.</li> </ul>

<b>Information</b>			
Lease ID:			
Agency:			
Location:			
FTE:			
Square Feet:			
Agency Leasing Manager:			
RSN Approval Date:			
Date PO Issued to Engage Broker:			
Procurement Release Date:			
Assigned Tenant Broker Company:			
Broker's Name:			
<b>Phase 1 (Pre-Lease Work)</b>			
<p><b>Phase 1</b> consists of the <b>work prior to the procurement and execution of the lease.</b> This phase includes (1) Evaluating Boundaries, (2) Evaluating Award/Negotiation Criteria, (3) Determining Present Market Rates, (4) Researching Other Properties, (5) Providing Written Assessments, (6) Providing a Strategic Leasing plan, and (7) Drafting/Reviewing Lease Forms.</p>	<table border="1" style="width: 100%; border-collapse: collapse;"> <tr> <td style="width: 80%;"><b>Grade:</b></td> <td style="width: 20%;"></td> </tr> </table>	<b>Grade:</b>	
<b>Grade:</b>			
<b>Phase 2 (Procurement)</b>			
<p><b>Phase 2</b> consists of the <b>procurement of the lease.</b> This phase includes (1) Drafting/Distributing Procurement Documents, (2) Assisting With Bidder's Questions, (3) Attending the Opening Bid, (4) Identifying Responsive Bids, (5) Providing Updated Market Rate Analysis, (6) Negotiating the Lease (7) Drafting a Written Summary, (8) Award Posting, and (9) Obtaining a Signed Commission Agreement.</p>	<table border="1" style="width: 100%; border-collapse: collapse;"> <tr> <td style="width: 80%;"><b>Grade:</b></td> <td style="width: 20%;"></td> </tr> </table>	<b>Grade:</b>	
<b>Grade:</b>			
<b>Phase 3 (Execution)</b>			
<p><b>Phase 3</b> consists of the <b>execution phase of the lease.</b> This phase includes (1) Drafting or Reviewing the Lease, and (2) Routing the Lease.</p>	<table border="1" style="width: 100%; border-collapse: collapse;"> <tr> <td style="width: 80%;"><b>Grade:</b></td> <td style="width: 20%;"></td> </tr> </table>	<b>Grade:</b>	
<b>Grade:</b>			
<b>Phase 4 (Build-Out)</b>			
<p><b>Phase 4</b> consists of the <b>build-out phase (if applicable).</b> This phase includes (1) Documenting Savings, (2) Space Planning, (3) Providing a Detailed Timeline, (4) Attending Meetings, (5) Providing Weekly Written Updates, (6) Assisting with Final Walk-Thru, and (7) Conducting the Transaction Close-Out Package.</p>	<table border="1" style="width: 100%; border-collapse: collapse;"> <tr> <td style="width: 80%;"><b>Grade:</b></td> <td style="width: 20%;"></td> </tr> </table>	<b>Grade:</b>	
<b>Grade:</b>			
<b>Comments</b>			
<table border="1" style="width: 100%; border-collapse: collapse;"> <tr> <td style="width: 80%;"><b>Overall Grade:</b></td> <td style="width: 20%;"></td> </tr> </table>		<b>Overall Grade:</b>	
<b>Overall Grade:</b>			

Signature: (x) \_\_\_\_\_ Prepared Date: \_\_\_\_\_

## Chapter 5.

## Leases under 5000 square feet

- New leases for space under 5,000 square feet may be obtained through direct negotiation with prospective lessors. FS 255.249(2)(b), an associated Administrative Rules 60-Hpromulgated by the Department of Management Services, (DMS); a **minimum of three (3)** written proposals must be acquired from three separate location.
  - If a minimum of three quotes cannot be obtained, detailed documentation **must** be provided to DMS as to 'WHY' quotes can't be provided.
- FS 255.25(2)(b) and (c), provides for departmental approval of these leases and the development of procedures and rules to ensure that leases for less than 5,000 square feet meet the criteria established by the Department of Management Services (DMS).
- Leases under 5,000 square feet must follow all rules applicable to competitive procured leases, including DMS legal review and approval. A Certification of Compliance must be signed by the Staff Director of General Services (ASG) for every lease action.
- The use of "Quote Submittal Form" must be used to procure a space of less than 5,000 square feet. Too many opportunities exist for misunderstandings if requirements are not completely revealed. The quote package may be modified to meet the needs of the program.
- Leases under 5,000 square feet require the Region Legal Counsel review and approval as to legality and content. However, DMS's will have the final approval.
- The preparation of the quote proposal specifications should be a joint effort between the Region General Services, (RGS), office and the program.
- The quote package consists of a standardized request for proposal form and various attachments which have been developed to facilitate a **uniform negotiated process throughout the department.** The document is basically divided into two sections:
  - The Quote Submittal Form section containing the specifications and space requirements for the prospective proposers to review and on which to submit their proposal.
  - Attachment "A" and information necessary for prospective lessors to complete and submit a responsive proposal package.
- Pursuant to FS 255.254, no state agency shall lease a facility without having secured an evaluation on sustainable building rating. The minimum acceptable for any propose leased facility shall not be less than 50, as determined by Energy Star Portfolio Manager (found at: [http://www.energystar.gov/index.cfm?c=evaluate\\_performance.bus\\_portfoliomanager.](http://www.energystar.gov/index.cfm?c=evaluate_performance.bus_portfoliomanager.))
- On a self standing building of 5,000 square feet or less that the department is to occupy the entire building will require to provide an Energy Performance Analysis (EPA) of 36 months of energy bills. If the Lessor **can't** provide 36 months of energy bills for the EPA a FEMP analysis will need to be performed.

## Process for leases under 5,000 square feet or less

1. The Region General Services (RGS) office determines there is a leasing need. Time to consider other leases in the area for consolidation if possible.

If a Tenant Broker (TB) is being engaged request the following;

- Market condition to the desire area.
- Space inventory available in desire area.
- Average market rate.

If TB is not being used, get projections through LoopNet or Star when possible.

2. RGS meets with the program to inform on market conditions and projected budget impact. Request a detailed number of FTE's and client service demographics as outline on Chapter 2 Certifying Space Needs.
  - Use the client service demographics to draw boundaries.
3. Prepare the DRSN and obtain the authorized approval signatures as outline on Chapter 2 Certifying Space Needs.
4. The signed DRSN, SAW, Boundaries Map and a justification for the lease action are electronically forwarded to ASG Central office for approval.
5. If a TB is not being engage, the RGS should begin preparing the quote package.
  - a. If a TB is being engage provide them the information so they can start the quote package.
6. It is recommended that if a TB is not being engage, the facilities services manager should drive the proposed boundaries to identify potential site for the new facility. Procure contact names and phone numbers for potential facilities.
7. Once the RSN is approved by DMS, begin a lease file with all the information available.
8. Advertised in the Department of Management Services (**DMS**) Vendor Information Portal (VIP) website: [http://vbs.dms.state.fl.us/vbs/main\\_menu](http://vbs.dms.state.fl.us/vbs/main_menu).
  - a. Supplemental advertising through newspaper, invitation by mail to owners, developers and Realtors in the area where the space is desired is recommended.
  - b. It is recommended to maintain a list of potential proposers who in the past requested notification of proposals or solicitations for the local area. These potential proposers should be notified by sending a copy of the advertisement of the quote proposal.
9. All quotes should be in the office by close of business on the deadline as specified in the quote package. Please note that emails with responses to the quote are acceptable.
10. Verify that proposals are on compliance and prepare a *Present Value Calculation* for total cost and complete the Synopsis form found at:

[Lease Forms / Leasing Procurement / Bureau of Property Services / Real Estate Development and Management/ Business Operations - Florida Department of Management Services \(myflorida.com\)](http://myflorida.com).

11. If less than 3 quotes are received, the Region should decide if the received proposal(s) are suitable for the department needs. If suitable, the Region must provide to DMS the necessary documentation to prove that diligent efforts have been made with no response.
12. When the quotes are received, the region the RGS must review the quotes for acceptance. Items to check for are:
  - Location - Is this space located within the boundaries?
  - Square Footage - Is the square footage same as the quote?
  - Rates - Are they within the market rates?
  - Parking - Did the proposal have the requested number of parking spaces?
  - Is the space available for occupancy within our time frame?
  - Did Proposer agree to all items within quote package?
  - Sustainable Energy Rate calculations and EPA if applicable.
  - Did Proposer submit the required paperwork with their package?
  - Check with the Department of State to verify the corporation/entity is registered with the state. If a corporation, make sure the corporation is active. If a foreign corporation, it must be certified to do business in the State of Florida.
  - If someone other than the owner has quoted space, they must have Power of Attorney from owner to do so.
13. Once the quotes are reviewed by the RGS, notify the program as to date, time and location of the evaluation. Contact the proposers and set up appointments.
14. Is recommended that a uniform evaluation criterion and score sheet to be used for committee members. This will help to maintain a uniform evaluation. Following are samples for evaluation criteria:
  - Facility condition and is the facility conducive to conduct business.
  - Proximity to preferred area.
  - Plenty of parking
  - Secure location
  - Access to public transportation
  - Amenities
  - Rate
  - Flexibility for future expansion
15. Train the committee members on the evaluation process for consistency.
16. Meet with the committee prior to the first site evaluation and complete the **Conflict-of-Interest** Form. Identify the proposers and proposed sites, review the criteria they are to use during the evaluation process, and ascertain if any committee members have a conflict if interest.
17. Once all the sites have been visited, collect the evaluations and get the committee feedback to draft a recommendation.
18. Prepare a Quote Synopsis (FM 4137A) and together with the evaluation results forward it to Headquarter ASG and the Program Director or designee for review and approval.
19. Once ASG and the Program Director or designee has approved the recommendation a notification of award or no award will be emailed to all evaluated proposers.

20. Contact the program and successful provider to begin space planning and decide on a deadline to complete drawings and provider send them to SFM for plan review and City/County for construction permit.
  - Either renovations are needed or not, the proposer must coordinate with the State Fire Marshal (SFM) for plans review and inspections. *A State Fire Marshal and City/County Certificate of Occupancy must be provided prior to move in.*
  - TB must keep track that the provider gets the SFM and City/County permits for the renovations.
  
21. The following lease documents should be prepared (prepared by TB; if engaged) and send it to DMS and via Memo Tracker to ASG, Program Director, HQ Budget, General Counsel for review and pre-approval:
  - Certificate of Compliance Form 4113.
  - Lease Agreement Form 4054, and all addenda.
  - Disclosure Statement Form 4114.
  - Copy of all quote proposals
  - Synopsis FM 4137A
  - Acceptance Letter
  - “Energy Star” Certification, If building is not “Energy Star” a letter of justification signed by the Regional Manager is needed.
  - Sustainable Building Rating calculations and EPA if applicable.
  - SFM approved plans letter.
  - Floor Plans
  - **NOTE:** The Certificate of Compliance is valid for 30 days from the date signed.
  
22. Once reviewed and pre-approved by the DMS send the following documents to the Lessor:
  - Lease Instruction Letter
  - Lease Agreement and all addenda.
  - Disclosure Statement
  - TB Commission Agreement (already signed by Tenant Broker)
  - Instruction on how to register in *“My Florida Market Place”*.
  
23. Upon receipt of signed leasing documents from Lessor, review forms for the following:
  - All pages have been initialed signed by Lessor.
  - No changes have been made to lease agreement.
  
24. Once review is complete, send the signed lease agreement to ASG for review and final signatures.
  
25. After signed by the General Legal Counsel and Assistant Secretary of Administration for signature.

26. Prepare a transmittal form and forward the following documents to DMS:

- Signed Lease Agreement with all addenda.
- Signed Disclosure Statement
- Tenant Broker Evaluation (If engaged)
- Executed Tenant Broker Commission Agreement (If engaged)

26. While waiting for the Final Approval of the lease documents is a good time to;

- Maintain contact with Lessor, or TB if engaged, on the renovation permits status.
- Contact the IT department for the future move of telephone and computer systems.
- Procure quotes for movers or other related relocation functions and get purchase orders.

27. Notify ASG Property Administrator of new lease location for insurance purposes.

28. Upon receipt of DMS approval, send the following to Lessor:

- Signed Lease Agreement and all addenda.
- Approved DMS Documents Letter

29. Send the following to Central Office:

- CARS Form
- New lease Encumbrance
- Scanned copy of the FA letter and lease documents
- Original Lease Document to ASSC Lease Payments

30. Notify HR of new lease facility Solaris Number.

31. Prior to occupancy, the following must be done:

- Physically measure space per the guidelines of DMS Method of Space Measurement.
- Complete a Handicap Accessibility Checklist.
- Obtain a copy of the Certificate of Occupancy.
- The SFM must have performed the 60% and a 100% final inspection of the premises. If renovations were required.
- Final punch list must be completed.

If occupancy is other than the effective date on the lease, prepare modification to Change Effective Date and Extend Term.

32. Verify that the following documents are in the leasing files:

- Original copy of Lease Agreement
- Certificate of Compliance
- Disclosure Statement
- Quotes received and Acceptance Letter
- Handicap Checklist
- Approved SFM Plans letter.
- Floor Plans



- Modification to Change Effective Date and Extend Term (if applicable)
- CARS form

33. The lease process is completed.

CHECKLIST (Leases less than 5,000 square feet)

Lease # \_\_\_\_\_

Quote Submission Date \_\_\_\_\_

Occupancy Date \_\_\_\_\_

Date Completed

- 1. RGS determines leasing needs, meets with program to discuss market conditions. \_\_\_\_\_
- 2. RGS requests staff information and client demographics from program. \_\_\_\_\_
- 3. RGS prepares and routes SAW & DRSN to Central Office. \_\_\_\_\_
- 4. RGS-TB prepares and submits quote package to Central Office for approval. \_\_\_\_\_
- 5. QSP advertised in VIP. \_\_\_\_\_
- 6. RGS-TB receives a minimum of three documented quotes. \_\_\_\_\_
- 7. RGS-TB and Program to evaluate proposed facilities \_\_\_\_\_
- 8. RGS-TB prepares the Synopsis and Recommendation Submit to ASG \_\_\_\_\_
- 9. ASG approves recommendation \_\_\_\_\_
- 10. Notification of award posted in VIP. \_\_\_\_\_
- 11. RGS or TB prepares lease documents and sends to DMS for pre-approval \_\_\_\_\_
- 12. RGS-Program and Lessor to begin space planning. \_\_\_\_\_
- 13. RGS receives final floor plans from lessor, if applicable. \_\_\_\_\_
- 14. Lessor submits floor plans to State Fire Marshal, if applicable. \_\_\_\_\_
- 15. RGS received pre-approval from DMS forwarded to Lessor for signature. \_\_\_\_\_
- 16. Received documents from Lessor, forward to ASG for signature \_\_\_\_\_
- 17. RGS received all signed documents from ASG. \_\_\_\_\_
- 18. Signed lease documents to DMS for final approval: \_\_\_\_\_
- 19. Physically measure space and complete handicap accessibility checklist. \_\_\_\_\_
- 19. RGS receives State Fire Marshal & Certificate of Occupancy from lessor. \_\_\_\_\_
- 20. Coordinate moving the program new space. \_\_\_\_\_
- 21. Forward DMS approved lease documents/fire insurance coverage request to:

- 1) Lessor \_\_\_\_\_
- 2) Fiscal \_\_\_\_\_
- 3) ASG \_\_\_\_\_

# CARS LEASE INFORMATION

	NEW	OLD
Lease#		

HQ:L NW:F NEE C:U SCR:Q SER S:X

Circuit	
County	
City	

	LEASE TERM	
	NEW LEASE	MODIFICATION
Executed Date		NEW END DATE
Begin Date		
End Date		

	NEW CONTRACT	MODIFICATION
Total Contract Amount		
Current FY Amount		

Vendor Information	
FEID #	
Contact Name	
Contact Phone	

Org Code	
----------	--

Budget Codes			
L1		CAT	
GF		YR	
SF		Effective Dt	
FID		OCA	
BE		EO	
IBI		Object	



State of Florida

Department of Children and Families

---

**ATTESTATION CONFLICT OF INTEREST**

Lease Number: \_\_\_\_\_

I \_\_\_\_\_ hereby certify that while I have taken part in the development or selection of criteria for evaluation, in the evaluation, and/or in the award processes forth above referenced lease, I am independent of and have no conflict of interest in the entities evaluated and selected.

Signature: \_\_\_\_\_

Title: \_\_\_\_\_

Address: \_\_\_\_\_

Date: \_\_\_\_\_



State of Florida  
 Department of Children and Families

QUOTE PROPOSAL  
LEASE #590:XXXX

Complete written Replies are due by \_\_\_\_\_ (date).

*It is the proposer's responsibility to be familiar with all aspects of the solicitation package outlined below and attached hereto. Specific responses and/or acknowledgment of each item must be made by the proposer's initials in each space provided and signature on the last page of the Submittal.*

The Department of Children and Families is seeking built-out office facilities and related infrastructure for occupancy by the Agency in \_\_\_\_\_, \_\_\_\_\_ County, Florida. Attachment A to this Quote Proposal includes the Agency Specifications detailing the build-out requirements.

The Department has authorized \_\_\_\_\_ of \_\_\_\_\_ to be its exclusive representative during this solicitation for space.

The proposal is for a "Gross Lease" therefore the lease rate must include base rent, taxes, all operating expenses (including, but not limited to, janitorial services and supplies, utilities, insurance, interior and exterior maintenance, recycling services, garbage disposal, security, etc.), furniture (if required), and any amortization of required tenant improvements to the proposed space. There shall be no pass through of additional expenses.

The Proposer will be responsible for build-out and clean up and shall provide the Department with a clean and ready to operate space.

General Specifications and Requirements

1. Net square footage required: \_\_\_\_\_. +/- 3% (acceptable range \_\_\_\_ to \_\_\_\_ square feet). Space approximate size and number of offices/rooms as specified in (Attachment A). Proposer must provide the location of the space in a building(s) (the "Proposed Space"), the amount of space available. Any and all references to square feet of the Proposed Space contained in a Reply must be "usable square feet" in accordance with the DMS Standard Method for Measuring Floor Area in Office Buildings (Florida Administrative Code 60H-2.003). The Department and DMS reserve the right to independently verify the space measurement.
2. Type of Space Required: \_\_\_\_\_ for use as \_\_\_\_\_
3. Parking: For this facility the department has determined that a minimum of (\_\_\_\_\_) non-exclusive parking spaces are required to meet the needs of its employees and clients. The required parking is to be under the control of the proposer, off the street, suitably paved and lined. This parking is to be provided as part of the lease at no cost to the department.  
Note: Proposer must provide evidence of control of all parking spaces being proposed. Permission to park is not control.
4. Term of Lease: The term of the lease will be \_\_\_\_ months from occupancy. The State requires a minimum of Ten (10) renewal options for One (1) year each under the same term and conditions as indicated in Article 2 of the lease agreement (Attachment C). Verify that you will be able to provide the State with this term and these renewal options. As to the renewal options, propose rates for each year of the renewal term(s).
5. Space to be made available: \_\_\_\_\_ Should the successful proposer fail to make the space available by the date specified in the proposal, the proposer shall be liable to the department for liquidated damages for each additional day until the space or portion thereof is made available for the said sum of \_\_\_\_\_ (\$\_\_\_\_\_) per day. If

delays are caused by the department, a written extension will be granted to the lessor. Unforeseen circumstances, beyond the control of the lessor (such as acts of God), which delay completion may be cause for the lessor to request an extension (in writing) from the project contact person. Final decision concerning granting an extension shall be the sole discretion of the department. If the delay is greater than \_\_\_\_\_ days, the Agency shall have the right to terminate the lease.

6. The successful proposer will provide the leased space to the department (lessee) for its exclusive use 24 hours per day, 7 days per week, during the lease term. The space to be leased by the department will be fully occupied during normal working hours from 7:30 a.m. to 5:30 p.m., Monday through Friday, excluding holidays, Saturdays and Sundays, and may be fully or partially occupied during all other periods of time as necessary and required at the full discretion of the department. Accordingly, services to be provided by the Proposer under the terms of the lease agreement, it will be provided during all hours of occupancy at no additional cost to the department.
7. Existing Building. To be considered existing, the proposed space must be enclosed with a roof system and exterior walls in place. The State requires a “turn-key” build-out by the Proposer. Therefore, Proposer shall assume all cost risks associated with delivery in accordance with the required space program specifications detailed in Attachment A
  - a) **All furniture needs must be considered as a Tenant Improvement and must be included as part of the Tenant Improvement Allowance. This may include but may not be limited to – reception/waiting room furniture, conference room tables and chairs, modular systems furniture, office chairs, break room equipment including but not limited to tables and chairs, and mailroom/work area furniture.**
  - b) The facility must comply or be renovated to comply with the requirements for Accessibility by Handicapped Persons as mandated by Chapter 553, Sections 553.501-553.514, Florida Statutes, the facility must comply or be renovated to comply with the requirements of 2012 FLORIDA ACCESSIBILITY CODE FOR BUILDING CONSTRUCTION adopted pursuant to S. 553.503. This document may be viewed at:  
[http://www.floridabuilding.org/fbc/committees/accessibility/aac/Changes\\_to\\_Law/Florida\\_Accessibility\\_Code\\_2012\\_ICC\\_FINAL.pdf](http://www.floridabuilding.org/fbc/committees/accessibility/aac/Changes_to_Law/Florida_Accessibility_Code_2012_ICC_FINAL.pdf)
  - c) Any renovations required must comply with all codes and fire safety standards adopted under Rules 69A-3.012 and 69A-60.002 of the Florida Administrative Code as the 2010 edition of the Florida Fire Prevention Code, which therein adopts the National Electrical Code, NFPA 70-2008, and the Life Safety Code, NFPA 101-2009. If renovations are required, the successful proposer will be required to submit two sets of plans for certification to State Fire Marshal before renovations commence as required by Florida Statutes 255.25(5). Renovation plans and specifications must be approved by the Division of State Fire Marshal prior to approval of the lease by the Department of Management Services. Building codes adopted by local jurisdictions shall be applicable to all lease construction.
  - d) All construction shall be performed by licensed contractors and the cost of construction, permits, inspections and fees shall be borne by the owner. A construction schedule will be provided by the owner to achieve the required occupancy date upon plan approval by the department. Proposer agrees to provide all builder and subcontractor license information upon request.
  - e) Each quote shall provide proof that the intended use of the facility by the state meets local

government requirements. This includes but, is not limited to, proper zoning, consistency with the local government comprehensive plan, a concurrence certificate and environmental permits

- f) Proposer offering multi-story buildings must meet the Building Code minimum of 50 pounds per square foot live load. Certification of Compliance must be supplied by the successful proposer.
8. Federal State and Local Requirements: The building owner shall comply with the applicable provisions of the Federal Occupational Safety and Health Act, The Federal Communications Act, The State of Florida Safety Rules (Chapter 440.56 Florida Statutes), The National Electric Code, and all other applicable laws, regulations, ordinances, codes and rules of any governmental entities that have jurisdiction. The lessor agrees to reimburse the agency for all losses, expenses, and damages arising from the violation of any of the above laws, regulations, ordinances, codes and rules.
9. Additional conditions that proposer shall agree in this quote submittal:
- a) Control of Property – For a Reply to be consider, it must be submitted a copy of the deed(s) evidencing clear title to the property proposed. If the Reply is being submitted by an authorized agent, broker or legal representative of the owner(s) submit a copy of the Special Power of Attorney authorizing submission of the proposal on behalf of the owner(s).
- b) If successful, proposer agrees to enter into a lease agreement on the Department of Management Services Standard Lease Agreement Form BPM 4054 and Addenda (Attachment \_\_\_\_).
- c) The successful proposer must provide a Disclosure of Ownership using the Department of Management Services' Form FM 4114 (Attachment \_\_\_\_\_).
10. Energy Star Rating: Pursuant to Section 255.254, Florida Statutes, no state agency shall lease a facility without having secured from the Department of Management Services (DMS) an evaluation of life-cycle costs based on sustainable building ratings. DMS implements Section 255.254, Florida Statutes, through Rule Chapter 60D-4 of the Florida Administrative Code (FAC). Pursuant to Rule 60D-4.007, FAC, an Energy Performance Analysis (EPA) is required before an agency considers leasing a facility larger than 2,000 gross square feet. The minimum acceptable Energy Star rating is 50.
- a) An Energy Star rating shall be developed for the proposed lease space with one of the following free software tools:
- 1) the Energy Star Portfolio Manager software, which is available at:  
[http://www.energystar.gov/index.cfm?c=evaluate\\_performance.bus\\_portfoliomanager](http://www.energystar.gov/index.cfm?c=evaluate_performance.bus_portfoliomanager)
  - 2) the Energy Star Target Finder software, which is available at:  
[http://www.energystar.gov/index.cfm?c=new\\_bldg\\_design.bus\\_target\\_finder](http://www.energystar.gov/index.cfm?c=new_bldg_design.bus_target_finder)
11. PUBLIC ENTITY CRIMES STATEMENT- A person or affiliate who has been placed on the convicted vendor list following a conviction for a public entity crime may not submit a proposal on a contract to provide any goods or services to a public entity, may not submit a proposal on a contract with a public entity for the construction or repair of a public building or public work, may not submit bids/proposals on leases of real property to a public entity, may not be awarded or perform work as a contractor, supplier, subcontractor, or consultant under a contract with any public entity, and may not transact business with any public entity in excess

of the threshold amount provided in Section 287.017, Florida Statutes, for Category Two for a period of thirty-six (36) months from the date of being placed on the convicted vendor list.

- 12. Vendor Registration in MyFloridaMarketPlace.- To comply with Rule 60A-1.030, Florida Administrative Code (F.A.C.), each successful vendor doing business with the State for the sale of commodities or contractual services as defined in section 287.012 F.S., shall register in the MyFloridaMarketPlace system, unless exempted under Rule 60A-1030(3), F.A.C., in order to be paid. If the vendor is already registered in MyFloridaMarketPlace the vendor may include a signed Certification of Registration. Vendors who are not subject to registration requirements should include proof of exemption by Rule from registration. Failure to include either proof of registration or exemption will not prevent the evaluation of the reply; however, such failure must be remedied prior to execution of a contract, if any.
- 13. Cooperation with the Inspector General.- Pursuant to section 20.055(5), Florida Statutes, contractor and any subcontractors understand and will comply with their duty to cooperate with the inspector general in any investigation, audit, inspection, review, or hearing.
- 14. ATTACHMENTS. - As integral part of this Quote package are the following:

- Attachment A Agency Specifications – provided as a construction cost guide for Offerors.
- Attachment B Boundaries – details the boundaries within which all Proposed Space must be.
- Attachment C Lease Agreement – This State Form Lease is provided to give the Offeror a general understanding of some of the terms and conditions required by the State should a lease be consummated. This is only a basic standard lease form. Other terms and conditions may be required by the State in order for a lease to be consummated.
- Attachment D Disclosure of Ownership – Each Offeror must complete and return this form with the Reply.
- Attachment E State Fire Marshal – This attachment provides general directives with regard to the Offeror’s compliance with the requirements of the State Fire Marshal.
- Attachment F Energy Performance Analysis – This Attachment provides a description of the State’s energy requirements for the Proposed Space.
- Attachment G Agency Disclosure and Commissions Agreement – This attachment provides an Agency Disclosure and Commissions Agreement relating to Tenant Broker as agent for the State.

*Nothing contained herein shall be deemed an offer to lease, and the State reserves the right to negotiate with all or none of the proposers in its sole discretion. Please note that the State has the right, at any time during the process, to reject any and all proposals that are not, in the State’s sole discretion, in the best interests of the State. By submitting a Reply each Offeror agrees that neither the Agency nor the Tenant Broker will be liable for any of the costs incurred by an Offeror in preparing and submitting a Reply.*

Inquiries and comments about this Quote Proposal should be directed to:

Department of Children and Families \_\_\_\_\_ Region \_\_\_\_\_  
 Name:



Title:	
Address:	
E-mail:	Facsimile:

**DESCRIPTION OF THE PROPOSED SPACE AND CERTIFICATIONS REGARDING PUBLIC ENTITY CRIMES AND LEASE TERMS AND CONDITIONS**

<b>A. CERTIFICATION Regarding PUBLIC ENTITY CRIMES STATEMENT to this Quote Submittal.</b>		
Offeror certifies that hasn't been placed on the convicted vendor list following a conviction for a public entity crime. Section 287.017, Florida Statutes.	<input type="checkbox"/> Yes	<input type="checkbox"/> No
<b>B. Certification Regarding <u>General Specifications and Requirements</u> to this Quote Submittal.</b> I hereby certify that if the Proposed Space is selected by the Department, I acknowledge and agree to abide to all requirements and conditions contained therein.		
1. Offeror acknowledges and agrees to the build-out and to provide the Department with a clean, ready to operate space.	<input type="checkbox"/> Yes	<input type="checkbox"/> No
2. Offeror acknowledges and agrees that the Proposed Space will be available in accordance with the Commencement Date and agrees to the liquidated damages until space is made available.	<input type="checkbox"/> Yes	<input type="checkbox"/> No
3. Offeror acknowledges and agrees that the Proposed Space will be available to the Department throughout the initial term and the renewal option periods as specified.	<input type="checkbox"/> Yes	<input type="checkbox"/> No
4. Offeror acknowledges and agrees that the Proposed Space will be a Full Service Gross Lease	<input type="checkbox"/> Yes	<input type="checkbox"/> No
5. Offeror acknowledges and agrees that the Proposed Space will meet the parking requirement set forth.	<input type="checkbox"/> Yes	<input type="checkbox"/> No
6. Offeror acknowledges and agrees that the Proposed Space will be "turn key" build-out in accordance with the specifications detailed in Attachment "A" following the Department's approval of an architectural layout provided by the Offeror/Landlord	<input type="checkbox"/> Yes	<input type="checkbox"/> No
7. Offeror acknowledges and agrees that the Proposed Space will execute the transaction with the State Standard Lease Agreement and related Addendum.	<input type="checkbox"/> Yes	<input type="checkbox"/> No
8. Offeror acknowledges and agrees that the Proposed Space will be acceptable and that it is compliant with all laws	<input type="checkbox"/> Yes	<input type="checkbox"/> No
9. Offeror acknowledges and agrees that the Proposed Space will meet all required Energy Performance Analysis detailed in Attachment "_____".	<input type="checkbox"/> Yes	<input type="checkbox"/> No
10. Offeror acknowledges and agrees to execute and be bound by the <b>TENANT BROKER USE AND Commissions Agreement.</b>	<input type="checkbox"/> Yes	<input type="checkbox"/> No

Signature of Authorized Representative:	Date:
---	-------

Offeror's Information			
Offeror's Name:			Title
Company:			FEID or SS number:
Address:		City/State/Zip:	
Phone Number:		Fax:	Email:

Proposal Information				
Address of proposed Facility:			Proposed Square feet:	
Requested Parking	Exclusive Parking	Non-Exclusive	Exclusive Offsite	Non-Exclusive Offsite

Base Lease Term	Rate Per Square Foot	Total Annual Rental
Year 1	\$	\$
Year 2	\$	\$
Year 3	\$	\$
Year 4	\$	\$
Year 5	\$	\$

Option Renewal Terms	Rate Per Square Foot	Total Annual Rental
Year 1	\$	\$
Year 2	\$	\$
Year 3	\$	\$
Year 4	\$	\$
Year 5	\$	\$
Year 6	\$	\$
Year 7	\$	\$
Year 8	\$	\$
Year 9	\$	\$
Year 10	\$	\$

Signature of Authorized Representative:	Date:
---	-------

**RENTAL RATE BRAKEDOWN**

Gross Space _____		Net Usable _____	
		Annual	Other Information
Net Rate per square feet – Year 1			Annual Escalation
Utilities			Total TI \$
Janitorial			Interest Rate %
Other Operational Cost			
Annual TI Amortization			

Each Reply must be signed by the owner(s), corporate officers of the owner or the legal representative(s) of the owner. The corporate, trade or partnership name must be stamped, written or typewritten, beside the actual signature(s).

**If a Reply is signed by a corporate officer or agent of the owner, written evidence of authority must accompany the Reply. If a corporation foreign to the State of Florida is the owner, written evidence of authority to conduct business in Florida must accompany the Reply.**

**CERTIFICATION**

I, \_\_\_\_\_, as owner, officer or authorized representative or agent \_\_\_\_\_, hereby agree that if awarded the lease as a result of the Department of Children and Families Quote Submittal, I will comply with the requirements, terms, and conditions stated in the Quote. I further certify that this Reply constitutes my formal proposal in its entirety.

Offeror’s Name:	Prospective Lessor’s Name:
-----------------	----------------------------

Authorized Signature:	Print or type name:
-----------------------	---------------------

Witness:	Print or type name:
----------	---------------------

Witness:	Print or type name:
----------	---------------------



Rest Rooms: Total of \_\_\_\_\_ Must meet the requirements of the Americans with Disabilities Act of 1990 and the requirements of the Accessibility by Handicapped Persons, Section 553.504 (12 – 13), Florida Statutes.

MEN'S WOMEN'S UNISEX

Public \_\_\_ Staff \_\_\_

Water Closets \_\_\_/\_\_\_ Urinals \_\_\_/\_\_\_ Lavatories W/Mirrors \_\_\_/\_\_\_

Provide an electric hand dryer in public restrooms and hand towel dispensers in employee and public restroom. All toilets shall be commercial grade power flush. Ceramic Tile shall be installed on both floor and walls, in all employee and public restrooms. Both public and employee restrooms must meet the requirements of the accessibility Requirements Manual published by the Department of Community Affairs and the Americans with Disabilities Act of 1990.

Refrigerated Drinking Fountains: Provide at least 1 per floor immediately adjacent to staff restroom.

Note: Must meet the requirement of ADA/ANSI Standard A117.11980, Specifications for Making Buildings and Facilities Accessible to and Usable by Physically Handicapped People. (Your local building official should have a copy.)

Lighting –Existing: All leased space to be provided with fluorescent lights to provide a minimum lighting level of:

- 10 foot-candles - halls and corridors, etc.
- 30 foot-candles - other public areas
- 50 foot-candles- offices, classrooms, conference rooms, etc.
- 50 foot-candles- computer rooms (Measured with a General Electric type 214 Light Meter)

Interior lighting must include emergency lighting for security and safety. All emergency lights shall have battery packs and be tested monthly.

RGS

Janitorial Services: The successful proposer agrees to furnish janitorial and cleaning services as part of this lease agreement. This includes furnishing all cleaning/maintenance equipment and cleaning supplies as required, including but not limited to drinking cups at water fountains, bathroom tissues, paper towels, trash receptacle liners, sanitary napkin disposal bags, toilet seat covers, liquid soap and doormats(weekly service is required) at entrances and exits.. All supplies are to be of good quality suitable for lessee's needs.

Window Covering –Existing: Exterior windows shall have blinds or shades to facilitate sunlight and energy control. Windows receiving direct sunlight shall be tinted or covered with energy saving film.

Floor Coverings: New carpeting will be installed prior to acceptance of the building. All individual

office spaces and conference rooms shall have at least 26 face weight loop commercial grade anti-soil carpeting to benefit acoustics, comfort and minimum maintenance in cleaning. Lounge/Break Room areas, reception areas, entrance, exits and restrooms will be ceramic tiled. Carpeting shall have UM-44D, ASTM D 3674-81 /UM-44D, fire and 3.5 kilovolts electrostatic conductivity rating. All vinyl and carpeting shall be a color and by a manufacturer acceptable to the department, which will choose from an assortment of at least three samples provided by the lessor. Carpeting shall be treated to reduce staining.

Weekly floor mat service is required; mats are to be placed at all entrances and exits.

**Maintenance and Repair:** On or about every annual anniversary of the date of occupancy, a maintenance inspection will be conducted by the facilities services manager and the lessor or his representative to review the condition of the building interior, exterior and site. Any discrepancies will be noted and a date of correction completion established. During the term of the lease, if maintenance and repair items appear that are emergencies or recurring problems that have not received attention within three working days, the lessee will have the right to complete the work, by a contractor of lessor's choice, and send the invoice to the lessor for payment. Non-responsiveness shall be deemed a breach of this lease. Failure by the lessor to correct or repair documented interior problems within 60 days after written notification by the lessee shall result in further legal action to obtain compliance. **If** the lessee is successful in court, the lessor agrees to pay any and all attorney's fees of the lessee, as well as impact costs due to decreased productivity.

**Interior identification:**

Lessor will provide interior main directory showing location of all programs, conference rooms, etc. Provide directory signs on each floor and in entrance suites showing programs and/or room use. Provide directional signs as required. Other ADA compliance raised letter signs with Braille shall be provided to identify all restrooms (handicap symbol on restrooms for person with disabilities), conference rooms, mechanical equipment, and other special use rooms. All rooms and/or offices are to be numbered consecutively.

**Exterior identification:**

The department shall have the option to require department signage on the building exterior to be provided by the lessor either at the top of the building or at the entrance. Lessor is to provide vinyl lettering on all entrance doors to designate program(s).

**Note:** All signs must meet requirements of DCA/ADA Accessibility Requirements Manual and are to be maintained by lessor.

### Security Requirements

- All outside doors shall be equipped with dead bolt or dead-latch locks and panic hardware.
- All interior office doors shall have key lockable locksets, turn-latch or push button on backside, master keyed. Specific locations of these locks will be assigned by DCF Program Administrator upon space-planning. If there are no common area restrooms in the building, all restrooms must also have lockable locksets.

- All opening outside windows shall have interior locks.
- Night illumination is required at all outside doors and all parking areas (minimum of 2 foot-candles) from dusk until dawn weekdays and weekends.
- Provide keys to all locksets in accordance with a master keying system acceptable to the department. Provide 4 master entrance keys.
- Doors leading from the reception area into the office area must be secured and equipped with both keycard access and a buzzer-like entry system to be controlled by the reception staff.

Fire Prevention: Lessor shall conform to all requirements of the State Fire Marshal and shall obtain pre-occupancy inspection and annual inspections by the State Fire Marshal as required by 633.085, Florida Statutes.

Heating, Ventilation and Air Conditioning: Provide sufficient climate control units with adequate ductwork, registers and grills sufficient to uniformly cool and heat the entire leased area. Unit(s) shall be equipped with remote sensors and with digital type thermostat controls in a (lockable room, NA) with color coded by zone mechanical plan placed on wall and laminated (This can be in the data/ phone room). Temperatures will be maintained to achieve an average zone temperature of 75 degrees Fahrenheit. Control thermostats will be located in areas to achieve proper zone temperature.

LAN room for data/phone must be cooled to 75 degrees Fahrenheit at all times (requires separate AC unit to maintain 75 degrees Fahrenheit).

Occupancy: The date of lease payment commencement will be determined by the date a Certificate of Occupancy is issued and final acceptance by the State Fire Marshal. In addition, the following criteria have been met:

- All installations are operational and complete;
- A letter of acceptance has been signed by the Issuing Officer.

Fire Prevention- Lessor shall conform to all requirements of the State Fire Marshal and shall obtain pre-occupancy inspection and annual inspections by the State Fire Marshal as required by 633.085, Florida Statutes.



## Chapter 6.

## Competitive procurements for leases over 5,000 square feet

- A competitive procurement is required for proposed leases of 5,000 or more square feet in privately-owned buildings. Leases for space in public buildings (federal, state, county, municipal, or other public property) (Section 255.2501, Florida Statutes). Facilities whose primary use will be the provision of care and living space for clients are exempt from the requirement of competitive proposal, as are educational occupancies.
- A leased space financed with local government obligations. Except when specifically authorized by the Appropriations Act, no executive state agency, public officer or employee shall enter into a contract on behalf of the state when the term of the contract is more than 5 years including renewals options.
- Rule 60H-1.015(1)(a), Florida Administrative Code, restricts an agency from enter a lease for space which total 5,000 square feet or more in a privately-owned facility or complex except upon the solicitation of competitive proposals.
- The procurement process can be accomplished by the following acceptable process:
  - ITB - Invitation to Bid
    - The successful Lessor must submit the lowest responsive bid proposal.
    - Bids must be determined in writing to meet all the requirements and criteria set forth in the invitation to bid.
  - RFP - Request for Proposal
    - If the Region determines that the use of an ITB is not practical, the leased space shall be procured by competitive sealed proposals (RFP). A writing justification signed by the General Services Manager needs to be submitted to DMS for approval.
    - The acceptability of the proposal is not limited to price.
    - A relative importance to price and other evaluation criteria factors are used in determining acceptability and award of the proposals.
  - ITN - Invitation to Negotiate
    - If it's determined that the use of ITB or RFP will not result in the best leasing value to the State
    - A justification letter from the General Services Manager to DMS for approval is required to procure leased space by ITN.
    - The agency's written determination must specify reasons to why negotiations may be necessary for the state to achieve the best leasing value and must be approved in writing by the agency head or his or her designee prior to the advertisement of an invitation to negotiate.
    - Cost savings related to the agency procurement process are not enough justification for using an invitation to negotiate.
- Competitive procurement specifications shall be made available simultaneously to all proposers and must include a detailed description of the space needs.

- Pursuant to FS 255.254(1) and Rule 60D-4.006, F.A.C., no state agency shall lease a facility without having secured an evaluation on sustainable building rating. The minimum acceptable for any propose leased facility shall not be less than 50, as determined by Energy Star Portfolio Manager at: [http://www.energystar.gov/index.cfm?c=evaluate\\_performance.bus\\_portfoliomanager](http://www.energystar.gov/index.cfm?c=evaluate_performance.bus_portfoliomanager)
- Leases over 20,000 square feet requires a Florida Energy Modeling Program, (FEMP), (Section 255.254, Florida Statutes), which must be submitted to DMS before final approval of the lease agreement can be obtained.
- For the procurement of leases over 5,000 square feet a pre-proposal conference must be held to inform prospective proposers of the details of the procurement package. The conference should be open to the public and recorded. On leases under 5,000 square feet, a pre-proposal conference is optional.
- Competitive procurement specifications may not be sole source (Section 255.04, Florida Statutes) oriented, although a single proposal response is permitted. A single proposal response should be evaluated completely. However, it is not necessary for the evaluation committee to apply evaluation points.
- Time and date for receipt of proposals, public opening and all contractual terms and conditions applicable to the procurement and the criteria to be used in determining acceptability of the proposal.
- The agency shall evaluate and rank responsive replies against all evaluation criteria set forth in the invitation to negotiate.
- Criteria that were not set forth in the procurement specifications cannot be used in determining acceptability of the package.
- After negotiations are conducted, must select the proposal determined to provide the best leasing value to the state.
- The intent of award must be notified to the successful lessor and posted with reasonable promptness.

The lease file must contain all documentation supporting the basis on which the award was decided. Including plain statement that explains the basis for lessor selection and sets forth the lessor's

NOTE: A competitive sealed reply in response to an invitation to negotiate, as defined in FS. 287.012, is exempt from s. 119.07(1) and s. 24(a), Art. I of the State Constitution until such time as the agency provides notice of a decision or intended decision pursuant to s. 120.57(3)(a) or until 20 days after the final competitive sealed replies are all opened, whichever occurs earlier.

### Proposal Packages

- Preparation of the proposal specification should be a joint effort between the Region General Services office and the program component(s) to be housed in the proposed facility.
- The proposal package consists of a standardized request for proposal form and various attachments which have been developed to facilitate a uniform competitive process throughout the department.
- The proposal package is basically divided into three sections:
  - The proposal invitation section containing information on preparation, submittal and evaluation.
  - The proposal submittal form section containing the specifications and space requirements for the prospective proposers to review and on which to submit their proposal.
    - The proposal packages must include language that the department reserve the right to reject any or all submissions when is deemed in the best interest of the state.
  - Attachments and information necessary for prospective lessors to complete and submit a responsive proposal.

### Solicitation of leasing space by proposal process:

- An ITB, RFP or ITN must be advertised in the Department of Management Services (DMS) Vendor Information Portal (VIP) website: [http://vbs.dms.state.fl.us/vbs/main\\_menu](http://vbs.dms.state.fl.us/vbs/main_menu).
- Supplemental advertising through newspaper, invitation by mail to owners, developers and Realtors in the area where the space is desired is recommended.
  - Is recommended to maintain a list of potential proposers who in the past requested notification of proposals or solicitations for the local area. These potential proposers should be notified by sending a copy of the advertisement for the request for proposal.
- Florida Administrative Code provides that entities having authority to consummate contracts or purchase orders are responsible for encouraging and promoting utilization of minority business enterprises.

### Preproposal Conference.

- Proposal packages must be distributed at least two weeks prior to the preproposal conference, it will allow proposers to be familiar with the contents. The proposal package must be distributed to anyone desiring information whether they attend the preproposal conference. However, the region may decide that proposal will only be accepted from preproposal conference attendees and must so state in the advertisement. If the preproposal conference is *mandatory*, agents or brokers may attend, however, they must have a written power of attorney to submit a response to a proposal on behalf of the owner of record as evidence of their representative status.

- On proposals over 5,000 square feet, must hold a preproposal conference open to the public and recorded. The Facilities Services Manager must prepare a sign in sheet for those attending, take minutes, and record a list of all questions asked. All preproposal conferences must be noted in the file even if no one attends.

A preproposal conference agenda is recommended as a standard conference format:

- Introduction: participant, purpose.
- Review the proposal specifications (architectural) with emphasis on services, term and options and special emphasis on miscellaneous needs, janitorial and maintenance responsibilities.
- Review evaluation process, criteria and weights.
- Review all attachments necessary to submit with the response to ensure that a responsive proposal will be received.
- Discuss lease approval process.
- Discuss the lessor responsibility to provide lease construction schedule, permitting code compliance and proper zoning requirements.
- Inform the attendees of the deadline to submit all the questions to the department and the date that the answers will be posted in VIP.
  - Any requests for clarification pertaining to the proposal package, the information should be furnished to all proposers.
  - Evidence that all proposers were equally informed should be kept in file. All changes and clarifications must be made and distributed to prospective proposers no later than schedule date on the table of events.
- The proposal opening date may be altered if in the best interest of the State of Florida as long as posted in VIP and notified to all interested parties.

NOTE: Any addendum posted in VIP to modify the proposal specification should disclose the protest language.

#### Receiving the proposal.

- All proposal responses received prior to the time set for opening will be kept unopened. Prior opening information concerning the identity of proposers and number of proposals received must not be disclosed. (ee s.119.07(3)(m) F.S.). A list of all responses received should be maintained in file. Each proposal must be time and date stamped upon receipt.
  - Responses to proposals, unidentified as to prospective lessor, should not be accepted.
  - Proposal responses opened by mistake or for identification purposes must be re-sealed in the original envelope. The person who opens the response must deliver it to the proper procurement official and place their signature and position title on the envelope, and the official must immediately write an explanation of the opening on the envelope.

- Proposal received after the exact time set for opening of the proposal, must be rejected as not responsive.
  - Late responses will not be considered for an award.
  - Hand delivered proposals will not be accepted after the exact time for opening has passed.
- A response to a proposal may be withdrawn by a proposer or his authorized representative prior to the proposal opening. The person making the withdrawal must make their identity known and must sign a receipt to withdraw the proposal.
- In the event a proposal solicitation yields no acceptable proposals, all proposal responses should be formally rejected by posting. A copy of the posting must be provided to the Central Office (ASG).
- When only one responsive offer is received it may be considered and accepted providing the proposal meets stated requirements.

#### Opening of the proposal.

- The Facilities Services Manager designated as the "Procurement Officer" will decide the exact time set for proposal opening has arrived and will so declare to those present. All responses received prior to that time will then be publicly opened. Only the following events should occur at the opening:
  - The proposal opening must be recorded.
  - Stating "proposals will now be opened" by the opening official.
  - Announce the name of each proposer and the address of proposed space.
  - No evaluation or questions of responsiveness are to be addressed at the proposal opening.
  - THE ONLY INFORMATION AVAILABLE TO ANYONE PRESENT AT THE TIME OF OPENING IS THE NUMBER OF PROPOSALS AND ADDRESSES
  - The Procurement Officer will announce the next step of the process scheduled in the table of events in the proposal package.
  - The proposal opening is concluded.

NOTE: Under FS 119.071 General exemptions from inspection or copying of public records. Sealed bids or proposals received by an agency pursuant to ITB, RFP and ITN are exempt from s. 119.07(1) and s. 24(a), Art. I of the State Constitution until such time as the agency provides notice of a decision or intended decision pursuant to s. 120.57(3)(a) or within 10 days after ITB or RFP opening and 20 days for ITN, whichever is earlier. If an agency rejects all competitive sealed replies in response to an ITN and concurrently provides notice of its intent to reissue the invitation to negotiate and reissues the ITN within 90 days after the notice of intent to reissue the ITN, the rejected replies remain exempt from s. 119.07(1) and s. 24(a), Art. I of the State Constitution until such time as the agency provides notice of a decision or intended decision pursuant to s. 120.57(3)(a) concerning the reissued ITN or until the agency withdraws the reissued ITN. A competitive sealed reply is not exempt for longer than 12 months after the initial agency notice rejecting all replies.

#### Synopsis of proposal.

- The synopsis of proposal format provides means to summarize all responses received in the competitive proposal process.

- The Synopsis form can be found at: [Lease Forms / Leasing Procurement / Bureau of Property Services / Real Estate Development and Management / Business Operations - Florida Department of Management Services \(myflorida.com\)](#)
- The synopsis must be typed and certified as accurate by the opening official as soon as practical after the opening meeting.
- All proposals received must be listed on the synopsis form including the non-responsive, listing a statement of reason(s) which rendered the non-responsive.
- Under the "Specified" column, list the requirements of the proposal package.

#### Determination of Responsiveness of the proposal.

- Objective determination of technical responsiveness of the proposal in accordance with established fatal criteria. A proposal determined not in compliance with the terms of the proposal specifications will not be evaluated further or given further consideration.
- Proposal responses which include qualifications or substantial deviations from the specifications set out in the proposal, will not be evaluated, and must be considered non-responsive, for example:
  - Any attempt to secure provisions for future changes in conditions, such as cost of living increases, higher utility costs, etc., during the lease period so that the total cost to the state cannot be determined when the proposal is evaluated.
  - Including qualifiers that provide that the proposal may be considered only if, prior to the date of award, the proposer receives (or does not receive) award under a separate lease.
  - Limit the rights of the state under any contract clause. A low proposer may be requested to delete objectionable conditions from the response if these conditions do not address the substance of the proposal.
- The facilities service's manager can seek clarifications as needed from any proposer when determining responsiveness.
- Non-responsive Offeror will be informed of the decision at the address shown in the proposal.

#### Evaluation Committee.

- The facilities services manager will serve as a resource to the committee but may not serve as a member of the committee.
- The evaluation committee will analyze each proposed facility in accordance with established criteria set out in the proposal.
- It is recommended that members of the committee should represent various areas of expertise for effective evaluation. These areas may include administration, operations, programs, budget, management information, civil rights (for handicapped accessibility) and facilities for maintenance.

- Each member must sign a No Conflict-of-Interest Certification before any evaluation take place.
- As scheduled on table of events the committee should visit proposed sites, evaluate, and provide input for justification for the award recommendation. The evaluation committee makes a recommendation to the Assistant Secretary of Administration.
- Each member of the evaluation committee must personally inspect the proposed facility and evaluate the location and building based on the evaluation criteria contained in the specifications. The proposer may accompany the committee only to help designate and provide access to the offered facility.

Awarding Evaluation Criteria Points.

- The proposer with the lowest present value calculation (PVC), cost will be awarded the maximum number of points of the evaluation criteria. The additional proposers will receive points calculated on the percentage difference between the lowest proposer and the proposer in question's PVC. Round points to nearest whole number.

Example: If the criteria weighting for basic rental costs is 25

	<u>Present Value</u>	<u>Ranking</u>	<u>Points Awarded</u>
Proposer A	\$ 206,132	Lowest	25
Proposer B	\$ 226,329	2nd Lowest	23
Proposer C	\$ 253,423	3rd Lowest	19
A. Low Proposal		\$ 206,132	
B. Second Lowest RFP		\$ <u>226,329</u>	
Difference		\$ 20,197 Divided by \$ 206,132 = 9.79	

Proposer B Proposal is 9.7 higher than low proposer, deduct 9.7 percent from 25 points = 22.6 (round-up) 23.

A. Low RFP	\$ 206,132
B. Third Lowest RFP	\$ <u>253,423</u>
	\$ 47,291 Divided by \$ 206,132 = 22.9%

Proposer C Proposal is 22.9 percent higher than low proposer, deduct 22.9 percent from 25 points = 19.2 (round -down) 19.

NOTE: If points are being awarded for renewal periods, a present value analysis must be run, and points awarded in the same manner as the basic years.

Proposal Evaluation Criteria.

- The region should review all criteria and select criteria's that determine weights for each solicitation. Lease rates over the terms expressed in the present value must be given the highest point award of any of the criteria.

### Proposal Recommendation and Award.

- The facilities services manager transmits the evaluation committee's recommendation package to the Assistant Secretary of Administration for concurrence and approval of the award. If the Assistant Secretary of Administration does not concur with the recommendation of award, strong documentation is required. The facilities services manager has the responsibility to document the files accordingly.
- The recommendation package to the Assistant Secretary of Administration should, at a minimum, consist of:
  - Copy of advertisement and proposal distribution list.
  - Copy of the proposal.
  - Synopsis of all proposals reviewed.
- Notification of Intent to Award or Notice of no award will be made by posting at the time shown in the proposal according to the timetable of events and will be made at the Time of Posting. The official notice must be by posting at VIP.

NOTE: It is recommended to schedule the proposal opening on Monday. So, in the event of a protest action it's received on a workday and avoid adding the weekend days between posting and receiving a Notice of Protests.

- Notification of proposal award is final when either or no protests are submitted or after all protests are resolved by an administrative hearing procedure. Subsequent appeals at district court level do not automatically mandate a delay in the proposal award. The risk of losing an appeal and having to give an award to a different lessor must be weighed against the immediacy of the needed for space and the possibility of having to move twice.
- Unless all offers are rejected, the proposal award must result in a binding lease or contract, which may not vary from the terms and conditions of the proposal in any material fashion. What constitutes a material deviation from the terms of the proposal is largely a matter of judgment on a case by case basis. Care must be taken to assure that any deviation must not have any effect on the competitive bidding process itself. Therefore, including terms in the final lease that might have change the way a prospective lessor may have fashioned his or her offer should be avoided.

### Cancellation of a proposal.

- Cancellation of the proposal means loss of time, effort, and money both by the state and by proposers. Proposal should not be canceled unless that cancellation is clearly in the public interest, i.e., when there is no longer a requirement for the facility;
  - When amendments to the proposal would be of such magnitude that a new proposal is desirable; or where required by the time limitations, or when a prior submission is protested, and the current advertisement must be canceled to stop proposer action.
- When a proposal is canceled prior to opening, all proposals that has been received will be returned unopened to the proposers.



**PROCESS FOR ACQUIRING LEASES  
5,000 SQUARES FEET OR MORE**

1. The region determines there is a leasing need. This is the time to look at other leases in the area to see if any offices can collocate.
2. Once leasing need has been determined, facilities services manager office requests an updated SAW and boundary base on supporting demographics.
3. Prepare the DRSN and obtain approval signature. Below you will find some suggested lengths of time for insertion into the calendar of events in the proposal.

<u>Date</u>	<u>Square Feet Requested</u>	<u>Pre-Proposal</u>	<u>Opening</u>	<u>Occupancy</u>
	1 - 4,999	OPTIONAL	4 weeks	24 weeks
	5,000 - 9,999	2 weeks	5 weeks	30
weeks	10,000 - 19,999	2 weeks	7 weeks	
	30-40 weeks			
	20,000 - over	2 weeks	10 weeks	40-52 weeks

4. Send electronically to Central Office the following:
  - Signed DRSN.
  - Program Request and SAW.
  - Justification for ITB, RFP or ITN that describes the nature of the lease action and the impact of this action on leasing/budget activities.
    - If there is an impact, the Region must provide a plan to minimize the negative impact on leases (e.g., plan to backfill existing space should a provider vacate the lease; require the provider to remain in current leased space; include exit clause in lease contract; etc.).
5. Contact Tenant Broker, if a broker is engaged.
  - a. If tenant broker is not being used, then the facilities services manager should drive the proposed boundaries to identify potential site for the new facility. Procure contact name and phone numbers for the potential facilities.
6. Tenant Broker or the Facilities Services Manager begins preparing the proposal package with the input from all the parties involved.
7. Prepare the advertisement for an ITB, RFP or ITN to be posted in VIP.
8. Once the RSN is approved by DMS, begin a lease file with information available.
9. Finish the proposal package.
10. On the first day of advertisement, contact the identified potential facilities owners to see if they will be interested on submitting a proposal. The proposal package must be ready to send out to potential proposers the first day of the advertisement.

11. On proposals of 5,000 or more square feet, you must hold a preproposal conference. A sign in sheet must be prepared for all in attendance; Facilities Services Manager is responsible for recording all questions asked and taking minutes. All preproposal conferences must be noted in file even if no one attends.
12. On the day of the proposal opening, post signs providing the time and location of the proposal opening placed strategically so that prospective lessors can easily find their way to the meeting place.
13. At the proposal opening, there shall be a minimum of two representatives from the Facilities Services Office present. One will open the proposals and announce the name of the offeror and location, the other will record the information. If there are proposers present, pass around a sign in sheet. **DO NOT DISCUSS THE RESPONSIVENESS OR UNRESPONSIVENESS OF THE PROPOSALS AT THE OPENING.** No copies of proposals will be made for proposers until the Facilities Services Manager has determined responsiveness.

NOTE: Sealed proposals received by an agency pursuant to invitations to requests for proposals are not public record until the agency provides notice of a decision or intended decision or 10 days ITB, RFP and 20 for ITN from the proposal opening, whichever is earlier. (F.S. 119.07) THE ONLY INFORMATION AVAILABLE TO PROPOSERS AT THE TIME OF OPENING IS THE NAME OF THE OFFEROR AND PROPERTY ADDRESSES.

14. After the opening, the Facilities Services Manager will review the proposals for responsiveness. Some items to check are:
  - Did the proposer sign the last page?
  - Is it notarized and witnessed?
  - Did the proposer initial all pages of proposal package?
  - Did proposer fill in all requested information on proposal form?
  - Did proposer respond on the proposal form?
  - If the proposer does not own the property, did they submit an authorization from owner to make a proposal or do they have a contract to purchase property?
  - Did they mark on boundary map where their property is located?
  - Did they include clear photographs of property offered?
  - Did they include site plan?
  - Did they include scaled floor plan?
  - If there are other tenants in the proposed space, did proposer submit existing lease acknowledgments?
  - If not a Florida corporation, did they submit authorization to conduct business in Florida?
  - If Florida Corporation did they submitted a certification of good standing from the Secretary of State.
  - If proposal is over 20,000 square feet, did they submit FEMP Analysis?
  - Did the proposer make any changes to proposal package?
  - Are the rental rates within the market rates?
  - Did the proposer indicate the parking on the site plan?
  - Does the proposal meet all the requirements of the proposal package?
15. Once the proposals are reviewed and deemed responsive, the Facilities Services Manager should notify the evaluation committee as to date, time and location of the evaluation. **DO NOT** give the addresses and rental rates of the proposed locations to the evaluation

committee or any program staff currently. Contact the proposers whose locations you are going to evaluate and set up appointments to obtain access to the offered facility.

NOTE: Any representatives from the programs present at the proposals opening, should be advised not to disclose the locations or rental rates to the evaluation committee or other associates; to prevent unfair pre-judgment of the proposed facilities.

16. Prepare evaluation criteria score sheet to be used by committee members. This will help to maintain a uniform evaluation.
17. Do Present Value of rental rates and calculate the point values.
18. At the evaluation, the Facilities Services Managers purpose is to be an advisor to the committee and make sure the evaluation runs properly. When you meet with the committee prior to the first site evaluation, identify the proposers and proposed sites. Complete the conflict of interest form After handing out the evaluation forms to the members, review the criteria they are to use during the evaluation process, and ascertain if any committee members have a conflict if interest.
19. During the evaluation, keep members focused on the criteria they are evaluating. If the proposer/owner is at the site and attempts to discuss matters which deviates from the proposal specifications or evaluation criteria, stop him politely and explain that this is not part of this evaluation criteria. Further, the prospective lessor is at the site only to assure access to the premises. They should be cautioned that no conversation relevant to the evaluation should take place between the offeror and the evaluation team. To permit this to happen will surely prevent a fair and impartial evaluation and will surely result in the appearance, if not the fact, of impropriety. Tell evaluation members not to discuss their evaluations between sites. Each site should be evaluated on its own merit, not compared to another site, and no evaluation team member should discuss his or her evaluation with another committee member. Even with these cautions firmly in place, however, try to keep the committee together so that anything observed on the premises will be observed by all team members and not just by some to assure equal knowledge and therefore equal and fair evaluations.
20. Once all the sites have been visited, go back to the office with the committee and conduct a debriefing. In the debriefing, collect the points assessed to each criterion and verify that each committee members follow the evaluation guidelines. If a committee member deviates from the guidelines established, ask that evaluator to review the criteria and to determine whether that review would result in a different score. If yes, allow the score to be changed by crossing through the old score once and substituting the new score. It is up to the evaluator to make whatever short notes necessary to remember the reason why the score was change and to justify the change later at the hearing. No point score may be change solely because the opinion of the evaluator deviates from others if the evaluation criterion was followed by the evaluator. Once they finish, and the evaluators scores are totaled, add the rental rate points, and total the evaluation points for the property. In the absence of some significant over riding consideration, the recommendation of the committee should be the property which combines the highest and which represents the best value to the Department.
21. Forward recommendation and the file to the ASG, Program Director, Budget, Assistant Secretary of Administration or designee for decision and direction to whom to make the award.

22. Once the Assistant Secretary of Administration or designee has determined to whom the award should be made, notification of proposal award or no award will be made by posting at the Time of Posting award. A proposer has 72 hours from the posting time of the award to file a Notice of Intent Protest, pursuant to Sec. 120.57(3).
23. Contact the Lessor to begin space planning and decide on a deadline in which the signed and sealed drawings should be approved and received in the facilities service's manager office.
24. Lessor sends the drawings and check to State Fire Marshal. Keep track of status of plans. Once you receive the approval, keep the approval letter and one copy of approved copy of plans in file.
25. Prepare a Lease Justification Form 4113A and submit the Regional Director for signature.
26. Prepare the following lease documents and send to DMS and ASG via Tracker Memo for review and pre-approval:
  - Signed Certificate of Compliance (Form 4113).
  - Lease Agreement Form 4054, and all addenda.
  - Disclosure Statement Form 4114.
  - Synopsis and BAFO
  - Acceptance Letter
  - "Energy Star" Certification, if building is not "Energy Star" a letter of justification signed by the Regional Director is needed.
  - Sustainable Building Rating calculations and EPA.
  - Energy Modeling if applicable
  - SFM letter of approval
  - Floor plan, drawn to scale, with dimensions and square footage calculations.
  - Legal ad posted in VIP.
  - Present Value Calculations (PVC) and evaluation criteria calculations
  - Original proposal specifications and attachments
- NOTE: Certificate of Compliance is only valid for 30 days from the Staff Director of General Services signature.
27. Once reviewed and pre-approved by the DMS and AS send the following documents to the Lessor:
  - Lease Instruction Letter
  - Lease Agreement and all addenda.
  - Disclosure Statement
  - Tenant Broker Agreement
28. Upon receipt of signed lease documents from Lessor, review forms for following:
  - All pages have been initialed and signed by Lessor.
  - All needed information has been filled out no blank spaces left in the lease document.
  - No changes have been made to lease without prior approval.

29. Submit the following to the Assistant Secretary of Administration for signature:
  - Lease Agreement, all addenda, and Disclosure Statement
  - Tenant Broker Agreement
30. Once the documents are returned from the Assistant Secretary of Administration's Office, review forms making sure that all pages were initialed and signed in the appropriate areas.
31. Then prepare the lease transmittal form and attach the following documents and forward to DMS for final approval:
  - Signed Lease Agreement and Disclosure Statement
  - Tenant Broker Agreement
  - Tenant Broker Evaluation
  - Floor plan, drawn to scale, with dimensions and square footage calculations.
32. While waiting for the Final Approval of the lease documents is a good time to;
  - Maintain contact with Lessor, or TB if engaged, on the renovation permits status.
  - Contact the IT department for the future move of telephone and computer systems.
  - Procure quotes for movers or other related relocation functions and get purchase orders.
33. Notify ASG Property Administrator of new lease location for insurance purposes.
34. Notify property administrator of new lease and location for insurance purposes.
35. Once DMS has approved documents, send the following to Lessor:
  - Lease Agreement and all addenda
  - DMS Approval Letter
36. Send the following to Central Office:
  - CARS Form
  - New lease Encumbrance
  - Scanned copy of the FA letter and lease documents
  - Original Lease Document to ASSC Lease Payments
37. Notify HR of new lease facility Solaris Number.
38. Prior to occupancy, the following must be done:
  - Physically measure space per the guidelines of DMS Method of Space Measurement.
  - Complete a Handicap Accessibility Checklist.
  - Obtain a copy of the Certificate of Occupancy.
  - The SFM must have performed the 60% and a 100% final inspection of the premises. If renovations were required.
  - Final punch list must be completed.

If occupancy is other than the effective date on the lease, prepare modification to Change Effective Date and Extend Term.

39. Verify that the following documents are in the leasing folder:

- Lease Agreement
- Certificate of Compliance
- Disclosure Statement
- Quotes received and Acceptance Letter
- Handicap Checklist
- Approved SFM Plans letter.
- Floor Plans
- Modification to Change Effective Date and Extend Term (if applicable)
- CARS form

40. The lease process is completed.

Sample

ATTESTATION OF NO CONFLICT OF INTEREST

LEASE NUMBER: \_\_\_\_\_

I, \_\_\_\_\_, hereby certify that I am independent of and have no conflict of interest in the entities to be evaluated and selected and do certify that:

No member of my immediate family or a business partner has no financial or other interest in any of the proposers' properties,

No gratuities, favors, or anything of monetary value has been offered to me or accepted by me from any proposer,

No employment by any of the RFP proposers within the last 24 months has been obtained,

No future employment with any of the proposers is planned or sought,

No other conditions which might cause a conflict of interest or appear as a conflict or interest are present.

I declare all the above statements are truthful and to the best of my knowledge.

\_\_\_\_\_  
(SIGNATURE)

\_\_\_\_\_  
(DATE)

Sample

SAMPLE NOTIFICATION OF AWARD LETTER

Date

Mr. John Doe  
John Doe Corporation  
Plaza Drive  
Tallahassee, Florida 32399

Re: Lease 590:9999

Dear Mr. Doe:

The evaluation of offers received by the department pursuant to the \_\_\_\_\_ proposal 590:XXXX has been completed. Because of this process, the offer submitted by John Doe Corporation, has been selected as the one with which the department will proceed toward its goal of entering into a lease for the needed space. However, no lease or agreement to lease space can be considered binding until approval from the Department of Management Services has been obtained. Compliance must be assured with the \_\_\_\_\_ Proposal, Florida Statutes and Florida Administrative Code.

You must now furnish an irrevocable Bank Letter of Credit, to the department within ten (10) calendar days after receipt of this notice. The Letter of Credit must be for an amount equal to \_\_\_\_\_ percent of the proposed lease obligations over the basic lease term which has been calculated to be \$ \_\_\_\_\_. The Letter of Credit should be in favor of the Department of Children and Families.

If you have any questions pertaining to this lease, please contact \_\_\_\_\_, Facilities Services Manager, at (850) 555-1212.

Sincerely,

General Services Manager

cc: Department of Management Services  
Central Office General Services



Sample

DEPARTMENT OF CHILDREN AND FAMILIES  
CERTIFICATION OF ACCEPTANCE

LEASE NO.: \_\_\_\_\_

CIRCUIT: \_\_\_\_\_

LOCATION: \_\_\_\_\_

THIS IS TO CERTIFY: The facility located at \_\_\_\_\_, owned by \_\_\_\_\_, and leased to, the Department of Children and Families under lease number \_\_, was inspected on \_\_\_\_\_ and found to be satisfactorily completed, according to the terms and conditions of the Proposal.

The facility has been measured in accordance with the "BOMA Standard Method of Space Measurement", of the State of Florida and was found to contain \_\_\_\_\_ net rentable square feet.

The date of acceptance as being available for occupancy to the Department of Children and Families is hereby established as \_\_\_\_\_.

The date the facility was to be available for occupancy was specified on the latest Time Change Order Number \_\_\_\_\_ as being \_\_\_\_\_.

\_\_\_\_\_ Since there is no difference in these two dates, the time account is hereby closed and no liquidated damages penalties are assessed against the lessor.

\_\_\_\_\_ Since there is a difference in these two dates indicating a delay of \_ days in the date of availability for occupancy, the lessor is liable for liquidated damages. The amount has been calculated by multiplying the number of days late by \$\_\_per day for a total of \$\_\_\_\_\_.\*

\* This amount will be subtracted from the first month and subsequent months (if necessary), rental payments to the lessor.

DEPARTMENT OF CHILDREN AND FAMILIES

BY: \_\_\_\_\_  
FACILITIES SERVICES MANAGER

BY: \_\_\_\_\_  
GENERAL SERVICES MANAGER



**DEPARTMENT OF CHILDREN AND FAMILIES**  
**Invitation to Negotiate for Leased Space**

---

**ITN # \_\_\_\_\_**

**\_\_\_\_\_ COUNTY, FLORIDA**

**CONTENTS**

- I. INTRODUCTION AND OVERVIEW**
- II. INVITATION TO NEGOTIATE - INSTRUCTIONS AND GENERAL INFORMATION**
- III. INVITATION TO NEGOTIATE - REPLY WRITING GUIDELINES; TERMS OF THE REPLY**
- IV. LEASE TERMS AND CONDITIONS**
- V. REPLY EVALUATION AND NEGOTIATION PROCESS**
- VI. PROTEST PROCEDURES**
- VII. Mandatory Requirements**
- VIII. ITN DEFINITIONS**
- IX. ATTACHMENTS**

## I. INTRODUCTION AND OVERVIEW

The State of Florida's Department of Children and Families, (hereinafter referred to as the "**Agency**" or the "**Department**") is seeking built-out office facilities and related infrastructure for occupancy by the Agency in \_\_\_\_\_, \_\_\_\_\_ County, Florida. **Attachment A** to this Invitation to Negotiate (**ITN**) includes the Agency Specifications detailing the build-out requirements. **Attachment B** contains the detailed boundaries for the facilities. The Agency has authorized \_\_\_\_\_ (**Tenant Broker Representative**) to be its exclusive representative during this solicitation for space.

All responses (hereinafter referred to as a "**Reply**" or "**Replies**") to this ITN must be received by the date specified in **Article II, Section A**, in written/typed form. The Reply must be sent, within the timeframes described herein, to the Department of Children and Families at the address specified in **Article II.A** of this ITN. No emailed or fax replies will be accepted.

The "Offeror" shall mean the natural person or the firm submitting a Reply to this Invitation to Negotiate, such person or firm being the owner of the proposed facility or a person or firm duly authorized to bind the owner of the facility. The term "State" shall mean the State of Florida and its Agencies. **Please see Article VIII regarding other definitions applicable to this ITN.**

The goal of this ITN is award a lease that best meets the needs of the State using a flexible, iterative process. Offeror(s) invited to negotiate may be given the opportunity to refresh the initial offer. At the conclusion of this negotiation process, the State may ask selected Offeror(s) to submit a written best and final offer, to memorialize all agreements reached during negotiations and to extend additional benefits to the State.

Note: This is an Invitation to Negotiate. Nothing contained herein shall be deemed an offer to lease, and the State reserves the right to negotiate with all, one or none of the respondents in its sole discretion. Please note that the State has the right, at any time during the process, to reject any and all proposals that are not, in the State's sole discretion, in the best interests of the State.

## II. INVITATION TO NEGOTIATE INSTRUCTIONS AND GENERAL INFORMATION

### A. REPLY DEADLINE

Complete written Offers must be received at the below address no later than 1:00 **PM (EDT)** on \_\_\_\_\_, 20\_\_\_\_. **Submissions must include:**

- Two Original Offers and two electronic copies, (on thumb-drives in PDF format)
  - Submission must be in a sealed envelope (or other sealed/suitable package)
  - With the ITN number (**ITN Number 590: \_\_\_\_\_**) clearly marked on the outside of the sealed envelope.
-

- The written Offers may be delivered via US Mail, private courier service, or hand-delivery to:

**DEPARTMENT OF CHILDREN AND FAMILIES**  
**the information here**

**(Note: Make sure**

**and the information in**

**II.A.D is the same.)**

Note that Replies which are late, unsealed, missing, and Replies which are deemed by the Agency (in the Agency’s sole discretion), to be substantially incomplete, inaccurate, vague, or illegible and will not be considered. Once received, all Replies and attachments shall become the property of the State of Florida exclusively and will not be returned.

1. It’s solely the Offerors’ responsibility to check the Department of Management Services (DMS) Vendor Information Portal (VIP) website: [http://vbs.dms.state.fl.us/vbs/main\\_menu](http://vbs.dms.state.fl.us/vbs/main_menu). at least forty-eight (48) hours before the closing time of this Invitation to Negotiate to verify that no additional amendments or requirements that may have been issued for this ITN.

**B. QUESTIONS REGARDING THE INVITATION TO NEGOTIATE**

Any questions or clarifications regarding this ITN or its specifications must be submitted, in writing (which may include e-mail), to the Official Contact Person specified in **subsection D of this Article II**. Any such questions or request for clarification must be received no later than \_\_\_\_\_ (AM/PM) on \_\_\_\_\_. No facsimiles or telephone calls will be accepted for any reason. A Solicitation Conference for this ITN will be held at the time and date specified in the Schedule of Events and Deadlines set fort in **Section II.C** below.

A Solicitation Conference is to review the ITN with interested Offerors so that areas of misunderstanding or ambiguity are clarified. The Department **(encourages but does not require that) (requires that) (Strike the choice this not applicable in each particular ITN)** all prospective Offerors participate in the Solicitation Conference, during which Offerors may pose questions.

Material clarifications, changes in specifications, dates, or any other information related to this ITN (as solely determined by the Agency) will be posted on the VBS Web Site along with this ITN.

**C. SCHEDULE OF EVENTS AND DEADLINES**

The process of soliciting and selecting Replies will follow the general schedule given below:

Date	Time	Schedule of Events
		Date on which the ITN is advertised on the VBS.
		*Solicitation Conference, see <b>Section “B”</b> above.

		All questions from potential Offerors due to the Department's Official Contact Person in writing, no further questions accepted after this date.
		Date Department will post answers to Offerors' questions on the VBS Web Site.
	<b>1:00pm</b>	Deadline for Offerors to submit Replies to the Department.
	<b>2:00pm</b>	*Opening of Replies
		Review for Mandatory Requirements.
		* Department's Evaluators Tour Selected Facilities.
		Anticipated date to list qualified Offerors, for Negotiation on the VBS Web Site.
		Initial Organizational Meeting of the Negotiating Team
		Estimated time period for negotiation with selected Offerors.
		Estimated date of posting of 'Notice of Intent' to Award on the VBS Web Site.
		Anticipated Lease Start Date.
<p>*All Offerors are hereby notified that the meetings noted with an asterisk (*) above are open to the public and may be electronically recorded by any member of the audience. Although the public is invited no comments and/or questions will be taken from Offerors or other members of the public (except for comments and questions of the potential Offerors at the Solicitation Conference).</p>		

NOTE: All meetings will be held at the Department's Offices located at \_\_\_\_\_ (insert address). All dates, times and locations are subject to change in the sole discretion of the Department. Such changes will be posted on the VBS Web Site.

**D. OFFICIAL CONTACT PERSON**

Inquiries and comments about this ITN should be directed to:

**(Note: Make sure that the information here and the information in II.A are the same)**

Department of Children and Families		Region	
Name:			
Title:			
Address:			
E-mail:		Facsimile:	

This contact person is the only authorized individual to respond to ITN comments and questions.

**E. OFFICIAL CONTACT PERSON - OFFEROR**

Each Offeror MUST provide contact information, title, company name, address, phone number, fax number and email address with their submittal form, **Attachment I**.

**F. PUBLIC ENTITY CRIMES STATEMENT**

A person or affiliate who has been placed on the convicted vendor list following a conviction for a public entity crime may not submit a proposal on a contract to provide any goods or services to a public entity, may not submit a proposal on a contract with a public entity for the construction or repair of a public building or public work, may not submit bids/proposals on leases of real property to a public entity, may not be awarded or perform work as a contractor, supplier, subcontractor, or consultant under a contract with any public entity, and may not transact business with any public entity in excess of the threshold amount provided in Section 287.017, Florida Statutes, for Category Two for a period of thirty-six (36) months from the date of being placed on the convicted vendor list.

**G. SPECIAL ACCOMMODATION**

Any person requiring a special accommodation at the Agency because of a disability should call the Agency Contact Person at least five (5) work days prior to the scheduled event. If you are hearing or speech impaired, please contact the Agency Contact Person by using the Florida Relay Service at (800) 955-8771 (TDD) (will this work/).

**H. CLARIFICATIONS**

Before award, the Agency reserves the right to seek clarifications, to request Reply revisions, and to request any information deemed necessary for proper

evaluation of Replies. Offerors may be requested to make a presentation, provide additional references, provide the opportunity for a site visit, etc. The Agency reserves the right to require attendance by particular representatives of the Offeror. Any written summary of presentations or demonstrations shall include a list of attendees, a copy of the agenda, and copies of any visuals or handouts, and shall become part of the Offeror's Reply. Failure to provide requested information may result in rejection of the Reply.

## I. Receipt of Proposals and Waiver of Minor Irregularities

- **Receipt Statement.** Replies not received at either the specified place, or by the specified date and time, or both, will be rejected and returned unopened to the Offeror by the Department. The Department will retain one unopened original for use in the event of a dispute.
- **Binding Proposals.** By submitting a Reply, each Offeror agrees that its offer shall remain a valid offer for at least **90** days after the Reply opening date and that, in the event the lease award is delayed by appeal or protest, such 90-day period is extended until entry of a final order in response to such appeal or protest.
- **Right to negotiate different terms and related price adjustments.** Offered prices/rates should assume those terms apply, but the Agency/Tenant Broker reserves the right to negotiate different terms and related price adjustments if the Agency determines that it is in the State's best interest to do so.
- **Waiver of Minor Irregularities.** The Department reserves the right to waive minor irregularities when to do so would be in the best interest of the State of Florida. A minor irregularity is a variation from the terms and conditions of this ITN which does not affect the price of the Offer or give the Offeror a substantial advantage over other Offerors and thereby restrict or stifle competition and does not adversely impact the interest of the Department. At its option, the Department may correct minor irregularities but is under no obligation to do so. In doing so the Department may request an Offeror to provide, and at the request of the Department the Offeror may provide to the Department, clarifying information or additional materials to correct the irregularity. However, the Department will not request and an Offeror may not provide the Department with additional materials that affect the price of the Offer, or give the Offeror an advantage or benefit not enjoyed by other Offerors.
- **Request to Withdraw an Offer.** A written request to withdraw an offer, signed by the Offeror, may be considered if received by the Department within 72 hours after the Reply opening time and date. A request received

in accordance with this provision may be granted by the Department upon proof of the impossibility to perform based upon an obvious error on the part of the Offeror.

**J. Rejection of All Replies.**

The Department reserves the right to reject all replies at any time, including after an award is made when to do so would be in the best interest of the State of Florida, and by doing so assumes no liability to any Offeror.

**K. Withdrawal of ITN.**

The Department reserves the right to withdraw the ITN at any time, including after an award is made when to do so would be in the best interest of the State, and by doing so assumes no liability to any Offeror.

**L. Reserved Rights After Notice of Award**

The Department reserves the right to schedule additional negotiation sessions with Offerors identified in the posting of a Notice of Award in order to establish final terms and conditions for contracts with those Offerors.

The Department reserves the right, after posting notice thereof, to withdraw or amend its Notice of Award and reopen negotiations with any Offeror at any time prior to execution of a contract.

**M. Public Records**

All electronic and written communications pertaining to this ITN, whether sent from or received by the Department, is subject to the Florida public records laws. Sealed proposals, or replies received by an agency pursuant to a competitive solicitation are exempt from s. 119.07(1) and s. 24(a), Art. I of the State Constitution.

**N. FAMILIARITY WITH LAWS**

The Offeror is required to be familiar with all federal, state and local laws, ordinances, rules and regulations that in any way affect this project. Lack of knowledge by the Offeror shall in no way allow relief from responsibility. All costs associated with compliance shall be borne by the Offeror. The Department shall exercise due care in response to questions concerning matters of law, but if in error, shall not be stopped from asserting the correct principles of law.

**O. LEGAL REQUIREMENTS**

Applicable provisions of all federal, state, county and local laws and administrative procedures, regulations or rules shall govern the development, submittal and evaluation of all proposals received in response hereto. Florida law, excluding Florida's provisions on conflict of laws, shall govern any and all claims and disputes, which may arise between persons submitting a Reply hereto and the Agency. Lack of knowledge of the law or applicable administrative procedures, regulations or rules by any Offeror shall not constitute a cognizable defense against their effect.



**P. VENUE**

The validity, interpretation and performance of the lease shall be controlled by and construed under the laws of the State of Florida. Any and all litigation arising under the lease must be instituted in the appropriate court in Leon County, Florida.

**Q. WAIVER**

The failure of any party to the lease resulting from this ITN to object to or take affirmative action with respect to any conduct of the other which is in violation of the terms of the lease shall not be construed as a waiver of the violation or breach, or of any future violation or breach.

**R. Vendor Registration in MyFloridaMarketPlace.** To comply with Rule 60A-1.030, Florida Administrative Code (F.A.C.), each successful vendor doing business with the State for the sale of commodities or contractual services as defined in section 287.012 F.S., shall register in the MyFloridaMarketPlace system, unless exempted under Rule 60A-1030(3), F.A.C., in order to be paid. If the vendor is already registered in MyFloridaMarketPlace the vendor may include a signed Certification of Registration. Vendors who are not subject to registration requirements should include proof of exemption by Rule from registration. Failure to include either proof of registration or exemption will not prevent the evaluation of the reply; however, such failure must be remedied prior to execution of a contract, if any.

**S. Cooperation with the Inspector General**

Pursuant to section 20.055(5), Florida Statutes, contractor and any subcontractors understand and will comply with their duty to cooperate with the inspector general in any investigation, audit, inspection, review, or hearing.

**III. ITN REPLY WRITING GUIDELINES; TERMS OF THE REPLY****A. REQUIREMENTS AND ORGANIZATION OF THE REPLY**

Each Reply should comply with the following requirements and follow the same general order of contents, described as follows. Please note that the items requested must conform to the specifications and requirements contained in this ITN. Offerors should use the checklist set forth in **Attachment J** to confirm that all items, information, and documentation required by this **Article III** and **Article VII** are included in the Reply.

**Mandatory Requirements.** An Offeror must comply with all of the Mandatory Requirements set forth in **Article VII** to be considered for evaluation and selection under this ITN. **A Reply that fails to meet the Mandatory Requirements will be deemed nonresponsive and will not be evaluated:**

1. Each reply **MUST** contain two hard copies of the original reply and two electronic copy (on thumb-drives in PDF format), of this ITN and the Offeror's reply with each page of the original initialed by the offeror.

2. Each reply must be bound and organized in a tab format with a table of contents that references all mandatory and evaluation criteria documentation.
3. The reply must include **Attachment B** –a map of the area around the proposed facility annotated with the location and boundaries of the proposed facility and the location of the Proposed Space in the facility.
4. The reply must include a copy of the recorded deed for the property on which the proposed space is located evidencing clear title to the property in the name if the Offeror or the Offeror’s lessor, principal, or optioner.
5. If it’s an authorized agent, broker or legal representative of the owner, submit a copy of the Special Power of Attorney authorizing submission of the proposal.
6. The reply must include evidence that an Offeror other than a natural person is duly organized and existing in good standing under the laws of its state or country of organization and is authorized and in good standing under the laws of the State of Florida to do business in the State of Florida.
7. The response on Attachment I.A and I.B- Answers to questions 1 – 10 – Answer must be “YES”, signed and dated.
8. Attachment I- “Rental Breakdown” must be completed.
9. **The reply must contain Attachment H** - the Tenant Broker Disclosure and Commissions Agreement must be completed, executed by the owner or on behalf of the owner.

**B. ADDITIONAL INFORMATION TO BE SUBMITTED WITH THE REPLY.**

1. **Photographs** – All Replies must include photographs of the current front, sides, and rear of the building in which the Proposed Space is located.
2. **Attachment E / Certificate of Occupancy** - If the Proposed Space Offered by the Offeror receiving the award requires renovation or tenant build-out or is in a building to be renovated the Offeror receiving the award must provide, prior to the date that the Proposed Space must be ready for occupancy by the Department, a certificate of occupancy evidencing that the work has been completed in accordance with the requirements of the State Fire Marshal as set forth in **Attachment E** and all other requirement for the space to be occupied.
3. **Attachment F for Proposed Space when actual utility bill data is Not available for the previous twelve (12) months, including Proposed Space that is not separately metered by the utility provider – Prior to award** the Offeror must submit a DMS approved Energy Performance Analysis based on a computer-based simulation completed in accordance with the requirements of Attachment F and Rule 60D-4.007, F.A.C.
4. **Attachment F for Proposed Space in a facility– prior to the award** the Offeror must submit a DMS evaluation of a life-cycle cost analysis prepared by an architect or engineer licensed in Florida or a “guaranteed energy, water, and wastewater performance savings contractor” as defined in Section 489.145, F.S,

in accordance with the requirements of Attachment F and Rule 60D-4.006, F.A.C.

5. **Certification of multi-story building live load for Proposed Space - *prior to the award*** the Offeror must submit a Certification of multi-story building live load by a structural engineer registered with the State of Florida.
6. **Initial Pages of the ITN** - All Replies must include a copy of this ITN with each page initialed by the Offeror.
7. **Public Transportation Schedule and Map** – All Replies must include a public transportation schedule and map identifying bus stops related to the Proposed Space and the distance from the building in which the Proposed Space is located.
8. **Historical Designation** - If the Proposed Space is being submitted as property with a historical designation submit proof of the designation.
9. **Test Fit** - Prior to award and final negotiation and selection of an Offer or Offers, a “test fit” of the Proposed Space relative to the need **may be** required, the expense of which shall be borne by the Offeror.
10. All Offerors must submit with the Reply a floor plan showing present layout and configuration of the Proposed Space with dimensions. An architectural floor plans with square footage measurements to include the total square footage equal to ‘net usable’ square feet and the ‘non-usable square feet. Floor plans to be drawn to scale (Example: 1/2” = 1’0”). The floor plan shall delineate space utilization consistent with Attachment A – Space Requirements (page \_\_\_\_). The floor plan shall include square footage measurements and square footage calculations summary to include: **(a)** total gross square feet, **(b)** total non-usable square feet and **(c)** total net usable square feet;
11. The final floor plan (if Offeror is selected for Award) will be as described in the specifications included herein, (**Attachment A**), or as otherwise negotiated with the Agency.
12. All Offerors must submit with the Reply the square footage calculations in accordance with the requirements of this ITN.
13. All Offerors must submit with the Reply a site layout with all parking spaces and utilization of spaces shown, with a minimum of parking spaces available to the Department.
14. **Attachment D** – the Disclosure of Ownership form must be completed, executed on behalf of the Lessor, and submitted with the Reply.

- 15. Attachment G** – Employment Eligibility Verification must be completed, executed on behalf of the Lessor, and submitted with the Reply.
- 16.** If the Proposed Space is occupied by a tenant at the time that the Reply is submitted the Offeror must submit with the Reply an acknowledgment by the tenant that the tenant will vacate the Proposed Space prior to the lease commencement date.
- 17.** Each Offeror must submit with the Reply Crime statistics from local Law Enforcement Agency for a one mile radius around the proposed location, for all crimes in the last reported year.

Note: Offerors should use the checklist set forth in **Attachment J** to confirm that all items, information, and documentation required by **Article III** are included in the Reply so that all items are considered for maximum scoring during evaluation.

### **C. TERMS OF THE REPLY**

The State reserves the right to negotiate the terms of a Reply including but not limited to such Reply's Financial Terms should a change in any such terms be in the best interest of the State. "Financial Terms" shall include, but not be limited to space square feet, rent rate, free rent, tenant improvement funds, lease term and details of any required build-out. **Note:** If the term of the lease is in excess of 1 fiscal year, including any and all renewal periods and including all leases which constitute a series of leases The State of Florida's performance and obligation to pay under this contract is contingent upon an annual appropriation by the Legislature.

- D. COST OF DEVELOPING AND SUBMITTING THE REPLY**  
By submitting a Reply each Offeror agrees that neither DMS, the Agency nor the Tenant Broker will be liable for any of the costs incurred by an Offeror in preparing and submitting a Reply.

### **IV. LEASE TERMS AND CONDITIONS**

The following is a listing of required lease terms and conditions your team must submit for review and consideration.

#### **DESCRIPTION AND MEASUREMENT OF PROPOSED SPACE**

- A. The Agency is seeking approximately \_\_\_\_\_ (+/- 3%) square feet of usable space (as defined below) within the described boundaries. Each Submission should specify the amount of space available and the address of such space.

The type of space required is \_\_\_\_\_ and will be used for \_\_\_\_\_  
\_\_\_\_\_.

Offeror must provide the location of the space in a building(s) (the “**Proposed Space**”), the amount of space available. Any and all references to square feet of the Proposed Space contained in a Reply must be “usable square feet” in accordance with the DMS Standard Method for Measuring Floor Area in Office Buildings (Florida Administrative Code 60H-2.003). The Agency and DMS reserve the right to independently verify the space measurement.

**B. LEASE COMMENCEMENT DATE**

The Proposed Space is to be made available on \_\_\_\_\_. Should the successful Offeror fail to make the space available by the date specified in the Reply, the Offeror shall be liable to the Agency for liquidated damages in the amount of \$\_\_\_\_\_ for each additional day until the Proposed Space is made available. Unforeseen circumstances, beyond the control of the Offeror/Lessor (such as acts of God), which delay completion may be cause for the Offeror/Lessor to request an extension (in writing) from the Agency, which the Agency may grant unconditionally, grant with conditions, or deny in the reasonable discretion of the Agency under the circumstances. If the delay is greater than \_\_\_\_\_days, the Agency shall have the right to terminate the lease.

**C. TERM AND RENEWAL OPTIONS**

The term of the lease will be \_\_\_\_\_ months from occupancy. The State requires a minimum of \_\_\_\_\_ renewal options for \_\_\_\_\_ years each under the same term and conditions as indicated in **Article 2** of the lease agreement (**Attachment C**). Verify that you will be able to provide the State with this term and these renewal options. As to the renewal options, propose rates for each year of the renewal term(s).

**D. FULL SERVICE (GROSS) RENTAL RATE**

The Offeror/Lessor shall provide the Agency with a Full Service (gross) lease structure. Therefore, the lease rate must include base rent, taxes, all operating expenses (including, but not limited to, janitorial services and supplies, utilities, insurance, interior and exterior maintenance, recycling services, garbage disposal, security, etc.), and any amortization of required tenant improvements to the Proposed Space (**Attachment A**). There shall be no pass through of additional expenses.

**E. PARKING**

At the minimum, respondents must make available not less than \_\_\_\_\_ spaces.

**F. PERMITTED USE BY THE STATE**

The State requires a “turn-key” build-out “gross lease” by the Landlord. Therefore, Offeror shall assume all cost risks associated with delivery in accordance with the required space program specifications detailed in **Attachment A**.

## **G. LEASE**

**Attachment “C”** to this ITN is the form lease agreement (and related addendum) which contains the general terms and conditions required by the State. Other terms and conditions may be required by the State in order to consummate a transaction. Each Offeror should review this form in its entirety and be prepared to execute it if it is awarded the lease. The lease must be approved by DMS.

## **H. PERMITTED USE BY THE STATE**

The State’s permitted use for the location will include general office purposes as well as appropriate appurtenant uses such as cafeteria, training areas, vending, computer rooms, etc.

## **I. ENERGY STAR RATING**

The State requires wherever possible that leased space be in an Energy Star rated facility. If the Proposed Space is in an Energy Star rated facility the Reply should so state and evidence thereof should be included in the Reply.

## **J. DISCLAIMER**

This ITN is for solicitation purposes only. It is neither an offer, contract nor an agreement of any kind. In submitting a Reply an Offeror agrees to be bound to the terms contained in that Reply for a minimum of ninety (90) days. Otherwise, neither the Agency nor the Offeror/Lessor shall have any legal rights or obligations whatsoever between them and neither shall take any action or fail to take any action in reliance upon any part of these discussions until the proposed transaction and a definitive written lease agreement is approved in writing by the Agency.

This ITN shall not be considered an offer to lease. The terms of any transaction, if finalized as a result of negotiations, shall not be final nor binding on either party until a Lease Agreement is executed by all parties. This ITN may be modified or withdrawn by the Agency at any time.

## **V. REPLY EVALUATION AND NEGOTIATION PROCESS**

**A. Reply Evaluation and Negotiation Process:** Using the evaluation criteria specified below, the Agency will evaluate and rank Replies and, at the Agency’s sole discretion, proceed to negotiate with Offerors as follows.

### **B. PROPOSAL EVALUATION**

1. **Mandatory Requirements.** An Offeror must comply with all Mandatory Requirements to be considered for selection under this ITN. The mandatory

requirements for this ITN are set forth in **Article VII**. The Department’s Official Contact Person or his or her designee will examine each Reply to determine whether the Reply meets the Mandatory Requirements. **A Reply that fails to meet the Mandatory Requirements will be deemed nonresponsive and will not be evaluated.** Meeting the Mandatory Requirements alone will not impact any ranking in the short listing process. An initial determination that a Reply meets the Mandatory Requirements does not preclude a subsequent determination of non-responsiveness.

Replies that meet the Mandatory Requirements of this ITN and are otherwise responsive will be eligible for evaluation. Such responsive Offerors will be evaluated and ranked and a Short List of Offeror(s) selected for negotiation. Following negotiations, the Department will post a notice of intended award on the VBS Web Site, identifying the Offeror or Offerors selected for award. Final contract terms will be established with the selected Offeror(s).

2. **EVALUATION CRITERIA.** All Submissions will be evaluated on the factors below:

<p><b><u>Criterion 1 - Rental rates per square foot for basic term of lease:</u></b>                  Rental rates evaluated, using total present value methodology for basic term of lease, by application of the present value discount rate of <span style="background-color: yellow;">    </span> Each Offeror’s rental rate per square foot for each year of the basic term of the lease will be totaled and averaged.</p> <p>The following formula will be used to calculate the score for this criterion:(Lowest average rental rate per square foot offered / Offeror’s average rental rate per square foot offered) x Total Maximum Points = Offeror’s Score for this criterion.</p> <p style="text-align: right;"><b>Maximum points: <u>30</u></b></p>	
<p><b><u>Criterion 2 - Rental rates per square foot for optional renewal terms of lease:</u></b>                  Rates evaluated, using total present value methodology for renewal terms of lease, by application of the present value discount rate of <span style="background-color: yellow;">    </span> Each Offeror’s rental rate per square foot for each year of the basic term of the lease will be totaled and averaged.</p> <p>The following formula will be used to calculate the score for this criterion:(Lowest average rental rate per square foot offered / Offeror’s average rental rate per square foot offered) x Total Maximum Points = Offeror’s Score for this criterion.</p> <p style="text-align: right;"><b>Maximum points: <u>15</u></b></p>	
<p><b><u>Criterion 3 - Location: The effect of the facility’s location on the efficient and economical conduct of Agency operations planned for the requested space. Proximity of facility to the department’s preferred area.</u></b></p>	
<p>A. Within 1 up to 5 mile radius</p> <p>B. More than 5 up to Ten 7 mile radius</p> <p>C. More than 7 and up to 10 mile radius</p>	<p><b><u>10 pts</u></b></p> <p><b><u>5 pts</u></b></p> <p><b><u>3 pts</u></b></p>

D. More than a 10 mile radius 0 pts  
Maximum points: 10

**Criterion 4 - Parking:** The Department needs  parking spaces.

- A. Exclusive contiguous parking adjacent to the building 10 pts
  - B. Non-Exclusive or non-contiguous parking adjacent to the building -  
8 pts
  - C. Exclusive or non-exclusive, contiguous or non-contiguous parking onsite 6  
pts
  - D. Exclusive offsite parking 3 pts
  - E. Non exclusive offsite parking 0 pts
- Maximum points: 10**

**Criterion 5 – Distance of the offered space from public transportation:**

- A. Within zero (0) to two tenth (0.2) mile radius 3 pts
  - B. More than two tenth (0.2) up to four tenth (0.4) mile radius 2  
pts
  - C. More than four tenth (0.4) up to five tenth (0.5) mile radius 1  
pt
  - D. More than five tenth (0.5) mile radius 0 pts
- Maximum points: 3**

**Criterion 6: Facility present condition- proximity to a physical plant, (including the physical characteristics of the building and the property the building sits on, adjacent structures and surrounding neighborhood.**

Each question below will receive 1 point if the answer is “yes” or 0 points if the answer is “no”.

- A. Are there good transportation links?
- B. Are there amenities (gas stations, restaurants, convenience stores, etc.) sufficient to meet the needs of the occupants of the Proposed Space?
- C. Does the building have a security system relatively adequate to protect the persons and property of the occupants of the proposed space?



D. Is the building well-maintained?

E. Are the surrounding properties, buildings, streets and sidewalks relatively well maintained, free from debris and visible evidence that the properties or buildings are in violation of any law, ordinance, rule or regulation, and any enforcement proceedings relating thereto, or are being used for any unlawful purpose

**Maximum points: 5**

**Criterion 7: Security issues posed by the building, associated parking and surrounding neighborhood, as evidenced by police reports, quality of exterior lighting and obstructed entrances/exits.**

Each question below will receive 1 point if the answer is “yes” or 0 points if the answer is “no”.

A. Are there perimeter controls such as gates, fences, walls, landscaping, etc. that restricts access to the property?

B. Are the parking lots well marked and well lit at night?

C. Are the sidewalks and walk ways unshrouded by over growth and easily seen and are there no hidden alley ways, access routes or hiding places?

D. Are there amenities present (lighting, patrolled hallways and parking areas, escorted ingress/egress, etc.) that aid after hour access and operation?

E. Do the police reports indicate that the Proposed Space is Located in a relatively safe neighborhood?

**Maximum points: 5**

**Criterion 8: The extent to which the offered space is designed for efficient layout and good utilization of space and energy** (i.e. house service units in proximity to interdependent units, Sustainable building Rating or E.A.

Energy Rating). Each question below will receive 1 points if the answer is “yes” or 0 points if the answer is “no”.

A. Is the offered space in a square shaped building and not a building that is in the shape of a rectangular or any other shape?

B. Is the present configuration of the offered space in an open plan that requires a lower tenant improvement cost?

**Maximum points: 2**

**Criterion 9: The contiguity of the offered space** (providing the aggregate square footage in a single building on a single floor is preferred):

A: Aggregate space in a single building, single floor on a first story.

**10 pts**

B: Aggregate space in a single building, on two or more floors or upper floor

**5 pts**

C: Aggregate space in two buildings, connected by sidewalks/overhangs, on a single floor

**2 pts**

D. Aggregate space in two buildings, connected by sidewalks/overhangs, on two or more floors

**1 pt**

E. Aggregate space in two buildings, not connected by sidewalks/overhangs or aggregate space in three or more buildings

**0 pts**

**Maximum points: 10**

**Criterion 10: Building BOMA Rating** (At time of submittal):

Class A- A Building = **4 pts**

Class B- B Building = **3 pts**

Class C - C Building = **2 pts**

Class D - D Building = **0 pts**

**Maximum points: 4**

**Criterion 11: The proximity of the proposed facility in relation to our community partners and**

**available space to accommodate expansion** (A community partner is a lead community-based care

agency or one of more its subcontracted providers of foster care and related services as defined and/or

contemplated in §409.1671, FS.).

Each question below will receive 2 points if the answer is “yes” or 0 points if the answer is “no”.

A. Is there sufficient space for future expansion?

\_\_\_\_\_

B. Is there sufficient space to accommodate our Community Partners (5,000 +/- SF)?

\_\_\_\_\_

C. Is the proximity of the proposed location within 3 miles of our community partners?

\_\_\_\_\_

**Maximum points: 6**

**3.Evaluation Methodology.** The Department will appoint [REDACTED] or more persons to evaluate the Replies who collectively have experience and knowledge in the program areas and space requirements for the built-out office facilities and related infrastructure being sought by this solicitation. The Department reserves the right to change the evaluators in its sole discretion upon posting the change on the VBS Web Site.

The Department's evaluators will evaluate Criteria 3-11 of each Reply, total the scores of each criterion to calculate each **Offer's Total Score for Criteria 3-11**, and forward their evaluation sheets to the Department's Official Contact Person. The Department's Official Contact Person or his or her designee will calculate the scores for Criterion 1-2 and 3-11 of each Reply and total the scores of each criterion to calculate each **Offer's Total Score for Criteria 1-2, and 3-11**.

The Department's Official Contact Person will average the total of all evaluators' Total Scores for Criteria 1-11 for each Offeror, yielding that Offeror's **Average Score for Criteria 1-11**. The Department's Official Contact Person will add each Offeror's Average Score for Criteria 6-8 and each Offer's Total Score for Criteria 1-11 yielding the **Offeror's Average Total Score**.

**4. Debriefing Meeting.** Following completion of the independent evaluations of the replies, the Departments Official Contact Person or his or her designee will hold a debriefing meeting with the evaluation team. The purpose of the meeting is to ensure that all evaluators have generally used the same information from the Offerors' replies as the foundation for their scoring, and that there have been no misunderstandings regarding the meaning of any evaluation criteria. Once scores are given to the Department's Official Contact Person, they may not be altered in any way, except to reconcile mathematical errors.

**5. Ranking and Short Listing.** The Department's Official Contact Person will rank the Replies from highest to lowest based on the Average Total Score of each Offeror. This ranking will serve as the recommended ranking of the Replies by the Department's evaluators. The Department's Official Contact Person will report the recommended ranking to the Department's Assistant secretary of Administration for the Department's Region in which the space being solicited by this ITN is located (**the "(AS)"**) or his/her designee, along with a recommended selection, based on the recommended ranking of the Replies, of the Offerors with which to commence negotiations. The Department's Official Contact Person will also provide the AS with a report on Replies deemed nonresponsive, which may include a recommendation that one or more otherwise responsive Replies be deemed ineligible for award due to the qualifications of the Offeror or the quality of the Reply.

The AS or his/her designee may accept the recommended ranking of the Replies by the Department's evaluators, in which case no scoring of the Replies by the AS or his/her designee will be required, or rescore and re-rank the Replies based upon the criteria set forth in **Section V.B.2**. The AS or his/her designee shall then select, based on the ranking of the Replies as recommended

by the Department's evaluators or as re-ranked by the AS or his/her designee, one or more Offerors (**the short list**) with which to commence negotiations. The AS or his designee will also make a determination as to whether to deem one or more respondents ineligible for award due to the qualifications of the Offeror or the quality of the Reply. Upon the selection of the short list of Offerors with which to commence negotiations by the AS or his/her designee, the Department will post the ranking of the Replies and the short list on the VBS Web Site.

**6. Negotiation Process for Final Selection** The Department intends to initially negotiate with up to [REDACTED] of the highest-ranked Offers in accordance with the ranking and the short list approved by the AS or his/her designee. The focus of the negotiations will be on achieving the solution that provides the best value to the State. The negotiations may be conducted serially by order of ranking or concurrently with all short-listed Offerors. However, the Department reserves the right, after posting notice thereof, to expand the short list to include additional responsive Offerors for negotiation or change the method of negotiation [e.g., concurrent versus by order of ranking], if it determines that to do either would be in the best interest of the State.

The Department reserves the right to require shortlisted Offerors to submit a supplemental reply or other submission prior to conducting negotiations. Notice of such requirement will be posted on the VIP Web Site.

The negotiation process is intended to enable the Department to determine whether and with whom it will contract and to establish the principal terms and conditions of such contract. There will be additional negotiations to finalize all terms and conditions of the contract after a notice of selection is posted.

After the initial negotiation session with the selected short-listed Offeror(s), in its sole discretion the Department shall determine whether to hold additional negotiation sessions and with which Offeror(s) it will negotiate. The Department reserves the right at any time after the initial negotiating session to:

- Negotiate with all responsive and responsible Offerors, serially or concurrently, to determine the best-suited solution. The ranking of Replies indicates the perceived overall benefits of the proposed solution, but after the initial negotiating session with the short-listed Offeror(s) the Agency/Tenant Broker retains the discretion to negotiate with other qualified Offerors as deemed appropriate.
  - Selected Offeror(s) is required to provide a Financial Support verifying his capability to meet
  - all required improvements to the proposed facility. Also, must provide an itemize tenant improvement construction cost detail for all proposed renovations; capital improvements must be listed separately.
- Schedule additional negotiating sessions with any or all responsive Offerors;
- Require any or all responsive Offerors to provide additional or revised detailed written proposals addressing specified topics;

- Require any or all responsive Offerors to provide a written best and final offer;
- Require any or all responsive Offerors to address services, prices, or conditions offered by any other Offeror;
- Pursue a lease with one or more responsive Offerors for the space and infrastructure encompassed by this solicitation, any addenda thereto, and any request for additional or revised detailed written proposals or request for best and final offers;
- Select one or more Offerors for the space encompassed by this solicitation, any addenda thereto, and any request for additional or revised detailed written proposals or request for best and final offers;
- Pursue the division of leases between responsive Offerors by type of service, type of space or the cost thereof, size of space or the cost thereof, configuration of space or the cost thereof, or geographic area, or any of them;
- Contract for the lease of a portion of the space being solicited by this ITN with one Offeror and the balance of the space being solicited by this ITN with one or more other Offerors;
- Award Lease(s) for less than the entire space or less than all services or amenities encompassed by this solicitation, or both;
- Arrive at an agreement with any responsive Offeror, finalize principal lease terms with such Offeror and terminate negotiations with any or all other Offerors, regardless of the status of or scheduled negotiations with such other Offerors;
- Negotiate concurrently or separately with competing Offerors.
- Decline to conduct further negotiations with any Offeror;
- Reopen negotiations with any Offeror;
- Take any additional administrative steps deemed necessary in determining the final award, including additional fact-finding, evaluation, or negotiation where necessary and consistent with the terms of this solicitation;
- Review and rely on relevant information contained in the Replies received pursuant to this ITN;
- Review and rely on relevant portions of the evaluations conducted pursuant to this ITN; and

- After posting notice thereof, to withdraw or amend its Notice of Award and reopen discussions with any Offeror at any time prior to execution of a contract.
- The Department also reserves the right to withdraw this ITN at any time, including after an award is made, when to do so would be in the best interest of the State of Florida, and by doing so assumes no liability to any Offeror.

The Department reserves all rights described elsewhere in this ITN. The Department has sole discretion in deciding whether and when to take any of the foregoing actions, the scope and manner of such actions, the responsive Offeror or Offerors affected and whether to provide concurrent public notice of such decision.

Negotiations between the Department and Offerors are exempted from the public meetings requirements of s. 286.001, F.S., and s. 24(b) of Article 1 of the State Constitution by s. 286.0113(2)(b)1, F.S. The initial organizational meeting of the negotiation team (if held) and the final meeting of the negotiation team to develop a recommendation for award are open to the public. Negotiation strategy meetings of the Department's negotiation team are exempted by s. 286.0113(2)(b)2, F.S. The Department will record all meetings of the Department's negotiation team.

**Exempted negotiations and Offerors' presentations to the Department's negotiating team will be recorded. Any discussions between or among any members of the Department's negotiating team about this ITN, any Reply, or any offer will be recorded. Except for discussions and communications between the Department's lead negotiator and an Offeror's lead negotiator, all discussions or communications between the Department's negotiating team and an Offeror's negotiating team must include all members of both teams.**

**7. Final Selection and Notice of Intent to Award Contract.** The Department will select for award of the lease the responsive Offeror or Offerors as determined by the RD or his or her designee to provide the best leasing value to the State based on the criteria set forth in **Section V.B.2.**

The Department's negotiating team will develop a recommendation as to the award that will provide the best leasing value to the State based on the selection criteria specified in **Section V.B.2.** In so doing, the negotiation team is not required to score the Offerors, but will base its recommendation on the criteria specified in **Section V.B.2.** The recommended award of the negotiation team shall serve as a recommendation only.

**8. The AS's Approval.** The RD or her/his designee will approve an award that will provide the best leasing value to the State, based on the criteria in **Section V.B.2,** taking into consideration the recommended award by the negotiating team. In so doing, the RD or his/her designee is not required to score the Offerors, but will base his or her recommendation on the criteria set forth above.

If the RD or his or her designee determines that two or more Replies most advantageous to the State are equal with respect to all relevant considerations, including price, quality, and service, the award will be made in accordance with Rule 60A-1.011, Florida Administrative Code and Section 295.187, Florida Statutes.

**9. Posting Notice of Award.** The Department will post a Notice of Intent to Award Lease, stating its intent to enter into one (1) or more leases with the Offeror or Offerors identified therein, on the VBS Web Site.

## **VI PROTEST PROCEDURES**

Any person who is adversely affected by the decision or intended decision made by the Department pursuant to this solicitation shall be made in accordance with sections 120.57(3) and 255.25(3)(d), Florida Statutes, and Rule 28-110, Florida Administrative Code and shall file with the Department a notice of protest in writing within 72 hours (Saturdays, Sundays, and state holidays excluded) after the posting of the notice of decision, or intended decision. The formal written protest shall be filed within ten (10) days after the date the notice of protest is filed (Saturdays, Sundays, and state holidays included).

### **A. Protests of Terms, Conditions and Specifications**

With respect to a protest of the terms, conditions and specifications contained in this solicitation, including any provisions governing the methods for ranking replies, awarding contracts, or modifying or amending any contract, the notice of protest shall be filed in writing within 72 hours (Saturdays, Sundays, and state holidays excluded) after the posting of the solicitation. For purposes of this provision, the term “the solicitation” includes any addendum, response to written questions, clarification or other document concerning the terms, conditions, or specifications of the solicitation. The formal written protest shall be filed within ten (10) days after the date the notice of protest is filed (Saturdays, Sundays, and state holidays included).

### **B. Bond Must Accompany Protest**

When protesting a decision or intended decision pertaining to this solicitation (including a protest of the terms, conditions and specifications contained in the solicitation), the protestor must post with the Department at the time of the filing of the formal written protest a bond payable to the Department in an amount equal to one percent (1%) of the estimated total rental of the basic lease period or \$5,000, whichever is greater. The bond shall be conditioned upon the payment of all costs that may be adjudged against the protestor in the administrative hearing in which the action is brought and in any subsequent appellate court proceeding. **FAILURE TO FILE THE PROPER BOND AT THE TIME OF FILING THE FORMAL PROTEST WILL RESULT IN A REJECTION OF THE PROTEST.** In lieu of a bond the Department may accept a cashier’s check, official bank check, or money order in the amount of the bond.

### C. Filing a Protest

A notice of protest, formal protest, and bond are “filed”, when received by the Department’s Official Contact Person listed in **Section II.D above**. Filing may be achieved by hand-delivery, courier, US Mail or facsimile transfer. Filing by email will not be accepted. All methods of delivery or transmittal to the Department’s Official Contact person shall remain the responsibility of the protestor and the risk of non-receipt or delayed receipt shall be upon the protestor. **FAILURE TO FILE A PROTEST WITHIN THE TIME PRESCRIBED IN S. 120.57(3), F.S., OR FAILURE TO POST THE BOND OR OTHER SECURITY REQUIRED BY LAW WITHIN THE TIME ALLOWED FOR FILING A BOND SHALL CONSTITUTE A WAIVER OF PROCEEDINGS UNDER CHAPTER 120, F.S.**

### VII. Mandatory Requirements

An Offeror must comply with all of the following Mandatory Requirements to be considered for evaluation and selection under this ITN. Please note that the items requested below must also conform to the specifications for Mandatory Requirements contained in **Attachment J. A reply that fails to meet the Mandatory Requirements or the specifications for Mandatory Requirements will be deemed nonresponsive and will not be evaluated.** Offerors should use the checklist set forth in **Attachment J** to confirm that all items, information, and documentation required by **Article III** and this **Article VII** are included in the Reply.

- A. Replies must be received at the specified place and by the specified date and time.
- B. All Offerors must comply with all requirements of and submit with the Reply all documentation required by **Article III, Section 2** regarding control of the Property.
- C. **Response to Article IV** – All Replies must include a response to all of the “Lease Terms and Conditions” in **Article IV**, clearly delineated and specific to **Article IV** questions, terms and requirements.
- D. **Attachment B** – All Offerors must submit with the Reply a map of the area around the proposed facility annotated with the location and boundaries of the proposed facility and the location of the Proposed Space in the facility.
- E. All Offerors must submit with the Reply a floor plan showing layout and configuration of the Proposed Space with dimensions. The final floor plan (if Offeror is selected for Award) will be as described in the specifications included herein, (**Attachment A**), or as otherwise negotiated with the Agency.
- F. All Offerors must submit with the Reply the square footage calculations in accordance with the requirements of this ITN. A summary to include: **(a)** total gross square feet, **(b)** total non-usable square feet and **(c)** total net usable square feet.



- G.** All Offerors must submit with the Reply a site layout with all parking spaces and utilization of spaces shown, with a minimum of [REDACTED] parking spaces available to the Department. An Offeror for Proposed Space in a multiple tenant facility must include the total number of parking spaces and parking commitment to other tenants.
- H.** **Attachment D** – the Disclosure of Ownership form must be completed, executed on behalf of the Lessor, and submitted with the Reply.
- I.** **Attachment F for Proposed Space when actual utility bill data is available for the previous twelve (12) months** - The Offeror must submit with the Reply a DMS approved Energy Performance Analysis based on actual utility bill data for the previous twelve (12) months completed in accordance with the requirements of Attachment F and Rule 60D-4.007, F.A.C..
- J.** **Attachment G** – Employment Eligibility Verification Offeror must be acknowledged and agreed in Attachment I.
- K.** **Attachment H** - the Tenant Broker Disclosure and Commissions Agreement must be completed, executed on behalf of the owner, and returned with the Reply.
- L.** **Attachment I** – All Offerors must submit with the Reply completed in its entirety with the Description of the Proposed Space and Certifications Regarding Public Entity Crimes and Lease Terms and Conditions with each page initialed on behalf of the Offeror, executed on behalf of the Offeror in both places where indicated, notarized and witnessed as specified therein. All certifications on page 2 must be checked “Yes” and completed, including the rate breakdown.
- M.** If the Proposed Space is occupied by a tenant at the time that the Reply is submitted the Offeror must submit with the Reply an acknowledgment by the tenant that the tenant will vacate the Proposed Space prior to the lease commencement date.
- N.** **Certification of multi-story building live load for Proposed Space** - the Offeror must submit with the Reply a Certification of multi-story building live load by a structural engineer registered with the State of Florida.
- O.** Each Offeror must submit with the Reply Crime statistics from local Law Enforcement Agency for a one mile radius around the proposed location, for all crimes in the last reported year.
- P.** All Offerors must initial each page of a copy of this ITN and submit it with the Reply.

Note: Pursuant to s. 119.071(1)(b)2, F.S., Sealed bids, proposals, or replies received by an agency pursuant to a competitive solicitation are exempt from the requirements of s.

119.07(1), F.S. and s. 24(a), Art. I of the State Constitution until such time as the agency provides notice of an intended decision or until 30 days after opening the bids, proposals, or final replies, whichever is earlier.

## VIII. ITN Definitions

**BOMA Building Classifications:** As defined by the Building Owners and Managers Association

**Class A:** Building has excellent location and access to attract the highest quality tenants. Building must be of superior construction and finish, relatively new or competitive with new buildings, and providing professional onsite management.

**Class B:** Building with good location, management and construction land tenancy. Can compete at low end of Class A. Class B building finishes are fair to good for the area and systems are adequate.

**Class C:** Generally an older building with growing functional and/or economic obsolescence. Building competes for tenants requiring functional space at rents below the average of the area.

**Class D:** An older building in need of extensive renovation as a result of functional obsolescence or deterioration.

**Boundary:** The precise geographic area defined by lines, streets, or roads, denoting the area for the acceptable location of a site/facility. To be considered within the specified given boundaries, the site or facility must be located within or abuts the defined lines of demarcation. (**Attachment B**)

**Business Day:** Working days occurring Monday through Friday, except legal holidays observed by the State of Florida. The terms “working days” and “business days” may be used interchangeably.

**Certificate of Occupancy:** The certificate issued by the appropriate official from the jurisdiction or jurisdictions where the offered property or facility is located, which signifies that the building or structure has met all construction requirements of such jurisdiction, and that the structure or facility may be occupied by people.

**Certified Minority Business Enterprise (CMBE):** A business which has been certified as a minority business, by the Office of Supplier Diversity, Department of Management Services.

**Common Area:** Any area of a building whose use is shared by other tenants. Examples include primary lobby, restrooms, primary (entrance) corridors, etc.

**Covenants:** Clauses in the lease or underlying deed, which define or limit the rights and obligations of the Lessor or the Lessee.

**Date of Occupancy:** The date following the issuance of any applicable certificate of occupancy when a building or facility has been inspected and is accepted by the Department.

**Day:** One calendar day.

**Department:** Refers to the State of Florida's Department of Children and Families, which is issuing this Invitation to Negotiate (**ITN**), or its successor in interest.

**Disclosure Statement:** A statement listing the names, addresses, occupations and percentage of ownership for any individual(s) who hold(s) 4% or more interest in the property or entity holding title to the property being leased to the State. ("**Attachment D**")

**Energy Performance Index:** A number describing the energy limits of a facility per square foot of floor area per year stated in BTU consumption per square foot per year. (**Attachment F**)

**Energy Star:** Is a joint program of the U.S. Environmental Protection Department and the U.S. Department of Energy helping us all save money and protect the environment through energy efficient products and practices.

**Exclusive Parking Spaces:** Parking designated and identified by the Offeror for the sole and exclusive use of the Lessee 24 hours per day, 7 days per week, without interference from or concurrent use by others. By offering parking spaces, the Offeror agrees to take whatever steps are necessary to assure that the Department enjoys exclusive use of those spaces as described here unless agreed otherwise in writing.

**Existing Building/Facility:** To be considered existing, the Proposed Space shall be enclosed with a roof system and exterior walls in place.

**Foot-candle:** The illumination of a surface one foot distance from a source of one candle, equal to one lumen per square foot. For purposes of this ITN, foot-candles shall be measured using a General Electric Type 214 Light Meter or its equal to be supplied by the Offeror.

**Full Service Lease:** Services to be provided by the Offeror, include all utilities, water, interior and exterior maintenance, recycling services, garbage disposal, janitorial services and supplies as specified in (**Attachment C**). Taxes and insurance shall be the responsibility of the Offeror. The Offeror shall be responsible for all build-outs and clean ups. Offeror shall deliver the completed space as specified by the within the proposal submittal form.

**Infrastructure –** Monthly reoccurring costs associated with separate facilities, to include but not limited to T1 wiring, 3 meg wiring and 6 meg wiring.

**Invitation to Negotiate:** The ITN consists of the package of documents by which the Department seeks to lease real property to meets its needs.

**Lease:** The Department of Management Services Lease contract entered into by a Department and the successful Offeror to this ITN. The lease shall incorporate, among other provisions, the contents of this ITN and the successful Offeror's response to this

ITN, except as specifically provided to the contrary in the lease document and which gives the Department a current possessor interest in the building or facility. The terms "lease" and "contract" may be used interchangeably.

**Lessee:** A person who acquires the right to possession and use of premises under a lease.

**Lessor:** A person who transfers the right to possession and use of premises under a lease.

**Market Rate :** Average rate of similar properties and services associated with those properties in a defined geographic region as defined by the engaged tenant broker's Independent Market Analysis.

**Offeree:** The Department who will acquire the right to possession and use of premises under a lease.

**Offeror:** Any firm or person, who submits written Replies for consideration, which will eventually transfer the right to possession and use of premises under a lease.

**Owner of Record:** Individual(s) or Entity listed as owner on recorded deed. Recorded Deed shall show Clerk of the Courts Book and Page Numbers.

**Proposal:** All materials submitted by an Offeror in response to this ITN.

**Public Entity Crime:** As defined in Section 287.133, Florida Statutes, means a violation of any state or federal law by a person with respect to and directly related to the transaction of business with any public entity or with an agency or political subdivision of any other state or with the United States, including but not limited to, any Replies or contract for goods or services, any lease for real property, or any contract for the construction or repair of a public building or public work, involving antitrust, fraud, theft, bribery, collusion, racketeering, conspiracy, or material misrepresentation.  
**(Attachment C, Addendum E)**

**Prospective Offeror:** Any firm or person who submits a Reply to the Department in response to this ITN.

**Renewal Rent -** The total rent over the renewal options of the lease.

**Rent -** The total rent over the base term of the lease.

**Responsive Proposal:** A proposal, which conforms in all material respects to this ITN.

**Standard Lease Agreement:** Lease Form Number 4054 on which leases for real property are written.

**State:** The State of Florida and its departments, boards and commissions, officers and employees.

**Subcontractor:** Any person other than an employee of the Offeror who performs any of the services listed in this ITN for compensation.

**“Test-Fit”:** A test fit is the first attempt to show the proposed office space criteria on paper in the form of a preliminary space plan. The test fit determines if you can "fit" into a specific space or how much space you will actually need to build out the space.

**Engaged Tenant Broker:** Contractor hired pursuant to Section 255.25 (3)(g), F.S., by the Department to work on its behalf to locate, negotiate and consummate a lease for requested space

**UPS:** Un-interruptible power supply.

Throughout this ITN, the singular may be read as plural and the plural as singular. Gender is intended to be neutral.

## **X. ATTACHMENTS**

This ITN contains numerous Attachments each of which is an integral part of this ITN. The Attachments include the following:

**Attachment A** Agency Specifications – provided as a construction cost guide for Offerors.

**Attachment B** Boundaries – details the boundaries within which all Proposed Space must be.

**Attachment C** Lease Agreement – This State Form Lease is provided to give the Offeror a general understanding of some of the terms and conditions required by the State should a lease be consummated. This is only a basic standard lease form. Other terms and conditions may be required by the State in order for a lease to be consummated.

**Attachment D** Disclosure of Ownership – Each Offeror must complete and return this form with the Reply.

**Attachment E** State Fire Marshal – This attachment provides general directives with regard to the Offeror’s compliance with the requirements of the State Fire Marshal.

**Attachment F** Energy Performance Analysis – This Attachment provides a description of the State’s energy requirements for the Proposed Space.

**Attachment G** Employee Eligibility Verification – This Attachment requires each offeror to enroll and participate in the Employment Eligibility Verification Program (“**E-Verify**”) administered by the U. S. Department of Homeland Security (“**DHS**”)

**Attachment H** Agency Disclosure and Commissions Agreement – This attachment provides an Agency Disclosure and Commissions Agreement relating

to The Tenant Broker as agent for the State. Each Offeror must execute and return a copy of this Agreement with the Reply.

**Attachment I** Completed entirely with the Description of the Proposed Space and Certifications Regarding Public Entity Crimes and Lease Terms and Conditions

**Attachment J** Documentation Checklist.

Each Offeror should read and understand each Attachment in its entirety prior to completion of the Reply. Additionally, should an Offeror’s Proposed Space be selected, the Offeror will, to the extent applicable, be required to adhere to the terms and conditions contained in all Attachments and/or shall be required to complete/provide the information required in any such Attachment. Indicate your review and understanding of the Attachments below.

**ATTACHMENT A**  
AGENCY SPECIFICATIONS

**ATTACHMENT B**  
BOUNDARIES

**ATTACHMENT C**  
Standard Lease Agreement

**ATTACHMENT D**  
Disclosure Statement

**ATTACHMENT E**  
DIVISION OF STATE FIRE MARSHAL  
Plans Review

**ATTACHMENT F**  
ENERGY PERFORMANCE ANALYSIS  
(EPA)

**ATTACHMENT G**  
*Employment Eligibility Verification*

**ATTACHMENT H**  
AGENCY DISCLOSURE AND  
COMMISSIONS AGREEMENT

**ATTACHMENT I**  
**DESCRIPTION OF THE PROPOSED SPACE AND CERTIFICATIONS REGARDING  
PUBLIC ENTITY CRIMES AND LEASE TREMS AND CONDITIONS**

<b>A. CERTIFICATION Regarding Article II-F, PUBLIC ENTITY CRIMES STATEMENT to this ITN.</b>		
Offeror certifies that hasn’t been placed on the convicted vendor list following a conviction for a public entity crime. Section 287.017, Florida Statutes.	<input type="checkbox"/> Yes	<input type="checkbox"/> No
<b>B. Certification Regarding Article IV, Lease Terms and Conditions to this ITN.</b> I hereby certify that if the Proposed Space is selected by the Agency, I acknowledge and agree to abide to all requirements and conditions contained therein.		
1. Offeror acknowledges and agrees to the build-out and to provide the Agency with a clean, ready to operate space.	<input type="checkbox"/> Yes	<input type="checkbox"/> No
2. Offeror acknowledges and agrees that the Proposed Space will be available in accordance with the Commencement Date and agrees to the liquidated damages until space is made available.	<input type="checkbox"/> Yes	<input type="checkbox"/> No
3. Offeror acknowledges and agrees that the Proposed Space will be available to the Agency throughout the initial term and the renewal option periods as specified.	<input type="checkbox"/> Yes	<input type="checkbox"/> No

4. Offeror acknowledges and agrees that the Proposed Space will be a Full Service Gross Lease	<input type="checkbox"/> Yes	<input type="checkbox"/> No
5. Offeror acknowledges and agrees that the Proposed Space will meet the parking requirement set forth.	<input type="checkbox"/> Yes	<input type="checkbox"/> No
6. Offeror acknowledges and agrees that the Proposed Space will be “turn key” build-out in accordance with the specifications detailed in Attachment “A” following the Agency’s approval of an architectural layout provided by the Offeror/Landlord	<input type="checkbox"/> Yes	<input type="checkbox"/> No
7. Offeror acknowledges and agrees that the Proposed Space will execute the transaction with the State Standard Lease Agreement and related Addendum.	<input type="checkbox"/> Yes	<input type="checkbox"/> No
8. Offeror acknowledges and agrees that the Proposed Space will be acceptable and that it is compliant with all laws	<input type="checkbox"/> Yes	<input type="checkbox"/> No
9. Offeror acknowledges and agrees that the Proposed Space will meet all required Energy Performance Analysis detailed in Attachment “F”.	<input type="checkbox"/> Yes	<input type="checkbox"/> No
10. Offeror acknowledges and agrees to enroll and participate in the Employment Eligibility Verification Program (“E-Verify”) administered by the U. S. Department of Homeland Security (“DHS”)	<input type="checkbox"/> Yes	<input type="checkbox"/> No
11. Offeror acknowledges and agrees to execute and be bound by the TENANT BROKER USE AND Commissions Agreement.	<input type="checkbox"/> Yes	<input type="checkbox"/> No

Offeror’s Information				
Offeror’s Name:			Title	
Company:			FEID or SS number:	
Address:		City/State/Zip:		
Phone Number:	Fax:	Email:		
Proposal Information				
Address of proposed Facility:			Proposed Square feet:	
Requested Parking	Exclusive Parking	Non-Exclusive	Exclusive Offsite	Non-Exclusive Offsite
Base Lease Term	Rate Per Square Foot		Total Annual Rental	
Year 1	\$		\$	
Year 2	\$		\$	

Year 3	\$	\$
Year 4	\$	\$
Year 5	\$	\$
<b>Option Renewal Terms</b>	<b>Rate Per Square Foot</b>	<b>Total Annual Rental</b>
Year 1	\$	\$
Year 2	\$	\$
Year 3	\$	\$
Year 4	\$	\$
Year 5	\$	\$
Year 6	\$	\$
Year 7	\$	\$
Year 8	\$	\$
Year 9	\$	\$
Year 10	\$	\$

## RENTAL RATE BREAKDOWN

Gross Space	Net Usable Annual	Other Information	
Net Rate per square feet – Year 1		Annual Escalation	
Utilities		Total TI \$	
Janitorial		Interest Rate %	
Other Operational Cost			
Annual TI Amortization			
Signature of Authorized Representative:		Date:	

Each Reply must be signed by the owner(s), corporate officers of the owner or the legal representative(s) of the owner. The corporate, trade or partnership name must be stamped, written or typewritten, beside the actual signature(s). **If a Reply is signed by a corporate officer or agent of the owner, written evidence of authority must accompany the Reply. If a corporation foreign to the State of Florida is the owner, written evidence of authority to conduct business in Florida must accompany the Reply.**

### CERTIFICATION



I, \_\_\_\_\_, as owner, officer or authorized representative or agent \_\_\_\_\_, hereby agree that if awarded the lease as a result of the Department of Children and Families Invitation to Negotiate, it will comply with the requirements, terms, and conditions stated in the Invitation to Negotiate and in the State of Florida, Department of Department of Management Services Standard Lease Agreement. In recognition thereof, the offeror's representative has read, understood, and agrees to comply with, and any intent by the offeror to deviate from the terms and conditions set forth therein may result, at the department's exclusive determination, in rejection of the reply.

Offeror's Name:	Prospective Lessor's Name:
-----------------	----------------------------

Authorized Signature:	Print or type name:
-----------------------	---------------------

Witness:	Print or type name:
----------	---------------------

Witness:	Print or type name:
----------	---------------------

Relationship to Owner:	
------------------------	--

**Sworn to, or affirmed & signed before me on:** \_\_\_\_\_  
Notary Public Signature

\_\_\_\_\_  
(Print, type or stamp commissioned name of notary)

(Date) \_\_\_\_\_  
\_\_\_\_\_ Personally Known      \_\_\_\_\_ Produced ID

Seal: \_\_\_\_\_ Identification Type: \_\_\_\_\_

**ATTACHMENT J  
DOCUMENTATION CHECKLIST**

**Offeror's Name:** \_\_\_\_\_ **Offeror's Representative's name:** \_\_\_\_\_

Offerors, please use the following checklist to confirm that all required documentation is submitted. Please note that the items requested shall conform to the specifications and requirements contained in this ITN.

**A. Documentation required from all Offerors:**

1. \_\_\_\_\_ Original and 2 hard copies of this ITN and the Offeror's Offer with each page initialed by the Offeror.\*
2. \_\_\_\_\_ 2 electronic copies of this ITN and the Offeror's Offer on Flash Drive in PDF format. \*

3. \_\_\_\_\_ Copy of the recorded deed for the property on which the Proposed Space is located evidencing clear title to the property in the name of the Offeror or the Offeror's lessor, principal, or optionor.\*
4. \_\_\_\_\_ Copy of the lease between the owner of the property on which the Proposed Space is located and the Offeror evidencing the right to sublease the Proposed Space, parking areas, and areas of ingress and egress, if the Reply is being submitted by the lessee of the Proposed Space. Any lease must encompass the entire time period of the basic lease and any renewal option periods as required by the Department.\*
5. \_\_\_\_\_ Copy of a special power of attorney from the owner of the property on which the Proposed Space is located to the owner's agent, broker, or legal representative if the Reply is by one of those persons or entities on behalf of the owner.\*
6. \_\_\_\_\_ Copy of the option to purchase between the owner of the property on which the Proposed Space is located and the Offeror evidencing that the Offeror has a valid option to purchase the property and parking areas from the owner of record which, if exercised, will result in the Offeror's control of the Proposed Space and parking areas prior to the intended date of occupancy by the Department, if the Reply is being submitted by the holder of an option to purchase. \*
7. \_\_\_\_\_ Copy of the option to lease the property on which the Proposed Space is located or the Proposed Space between the owner of the property and the Offeror evidencing that the Offeror has a valid option to lease the property and parking areas from the owner of record with authorization to, in turn, sublease which will result in the Offeror's control of the Proposed Space and parking areas prior to the intended date of occupancy by the Department, if the Reply is being submitted by the holder of an option to lease. Any lease and sublease must encompass the entire time period of the basic lease and any renewal option periods as required by the Department.\*
8. \_\_\_\_\_ If parking, ingress, or egress is by way of an easement, provide copies of the recorded deed(s) evidencing ownership of the areas of parking, ingress, and egress and the easement granting the rights of parking, ingress, and egress showing the Clerk of Court's book and page.\*
9. \_\_\_\_\_ Evidence that an Offeror other than a natural person is duly organized and existing in good standing under the laws of its state or country of organization and is authorized and in good standing under the laws of the State of Florida to do business in the State of Florida.\*
10. \_\_\_\_\_ A response to all of the "Lease Terms and Conditions" in **Article IV** clearly delineated and specific to **Article IV** questions, terms and requirements.\*
11. \_\_\_\_\_ Photographs of the current front, sides, and rear of the building in which the Proposed Space is located. If the Proposed Space is to be constructed submit architectural renderings instead of photographs.\*
12. \_\_\_\_\_ A Certification of multi-story building live load by a structural engineer registered with the State of Florida prior to the award.

13. \_\_\_\_\_ A public transportation schedule and map identifying bus stops related to the Proposed Space and the distance from the building in which the Proposed Space is located.
14. \_\_\_\_\_ Proof of historical designation if the property is so designated.
15. \_\_\_\_\_ **Attachment B** - A map of the area around the proposed facility annotated with the location and boundaries of the proposed facility. \*
16. \_\_\_\_\_ A floor plan showing present layout and configuration of the Proposed Space with dimensions. \*  
The final floor plan (if Offeror is selected for Award) will be as described in the specifications included herein, (Attachment A), or as otherwise negotiated with the Agency.
17. \_\_\_\_\_ A scaled site layout with all parking spaces and utilization of spaces shown, with a minimum of parking spaces available to the Department. In a multiple tenant facility must include the total number of parking spaces and parking commitment to other tenants.\*
18. \_\_\_\_\_ **Attachment D** – The Disclosure of Ownership form completed and executed on behalf of the Lessor.\*
19. \_\_\_\_\_ **Attachment G** – The Employment Eligibility Verification form must be completed and executed on behalf of the Lessor.
20. \_\_\_\_\_ **Attachment H** - The Tenant Broker Disclosure and Commissions Agreement must completed and executed on behalf of the owner.\*
21. \_\_\_\_\_ **Attachment I** – The Offeror’s contact Information, The square footage calculations in accordance with the requirements of this ITN. The otherwise properly completed Description of the Proposed Space and Certifications Regarding Public Entity Crimes and Lease Terms and Conditions with each page initialed on behalf of the Offeror in pen and ink, executed in pen and ink on behalf of the Offeror in both places where indicated, notarized and witnessed as specified therein in pen and ink, and with all certifications on page 2 checked “Yes”.\*
22. \_\_\_\_\_ If the Proposed Space is occupied by a tenant at the time that the Reply is submitted the Offeror must submit an acknowledgment by the tenant that the tenant will vacate the Proposed Space prior to the lease commencement date.\*
23. \_\_\_\_\_ Crime statistics from local Law Enforcement Agency for a one mile radius around the proposed location, for all crimes in the last reported year.\*

\* **Each item noted above with an asterisk (\*) is a Mandatory Requirement and must be submitted with the Reply.**

**Each Offeror must comply with all of the Mandatory Requirements and the specifications for the Mandatory Requirement contained in this Attachment J and the Mandatory Requirements must be submitted with the Reply to be considered for**

**evaluation and selection under this ITN. A reply that fails to meet the Mandatory Requirements will be deemed nonresponsive and will not be evaluated.**

The items noted above without any asterisk should be submitted with the Reply if possible, but in any event prior to the date scheduled for the award of the lease, or, where indicated, prior to the date that the Proposed Space must be ready for occupancy by the Department.

**Attachment A**

The successful Offeror shall furnish all services. Services provided by the Offeror shall include all necessary build-out and clean up. The Offeror shall provide the Department with clean, ready to operate space. Services shall also include payment of utilities, trash removal, storm water fees, recycling service, interior, common area and exterior maintenance, janitorial services, monthly pest control, telephone purchase and installation and other services as required.

Space to be designed to accommodate the approximate size and number of offices/rooms listed below. The proposer shall provide a scale drawing of the proposed.

**SPACE REQUIREMENTS:**

Number and approximate size of offices and rooms for internal space requirements

Number	Type	Size Each	Net Sq/Ft	Special Requirements



**\*\* - NOTE: Restrooms, mechanical rooms, janitorial closets, stairwells, etc., are NOT to be included in calculating net rentable square footage proposed.**

**Lighting –Existing:** All leased space to be provided with fluorescent lights to provide a minimum lighting level of:

10 foot-candles - halls and corridors, etc.

30 foot-candles - other public areas

50 foot-candles- offices, classrooms, conference rooms, etc.

50 foot-candles- computer rooms (Measured with a General Electric type 214 Light Meter)

Interior lighting must include emergency lighting for security and safety. All emergency lights shall have battery packs and be tested monthly.

**Electrical Requirements:** Proposer shall provide: three (3) duplex receptacles per office, maximum three (3) offices per circuit; three (3) dedicated circuits for each breakroom; class “B” surge protection on all 120/208 circuit break panels; Dedicated circuits as required for printers, copiers, etc. ground resistance test to assure less than 5 ohm better; housekeeping circuits separate from office circuitry; building must comply with National Electric Code latest edition at the time of occupancy; 20-amp circuit required for every six (6) workstations or computer stations.

**Telephone and Computer Requirements:** The Department uses VOIP (Voice Over IP) as their phone system. However, there may be a need for phone lines to be installed for fax lines. The building owner shall provide the required facilities and labor to install communications for voice and data. Telephone and data drops to be indicated on floor plans when available.

### **Wiring Installations**

Additional line installations not specified in this section shall be indicated on blueprint as to their termination points. These lines will be installed technically equivalent to those installed in the permanent and modular office locations and will require a Dual Modular Wall Jack. Note: May require only a Single Modular Wall Jack.

Two (2) of the four (4) pairs from the voice station wire will be terminated on the RJ45's. The level 5e data station wire (350E Data Twist or equivalent) will be terminated on the RJ 45 plugs.

The installation shall include at least one (1) station wire runs (one 4-pair data line) to each permanent office location. All pairs from the station wires shall be terminated in each office on a quad wall plate using orange RJ45 jacks for data and blue RJ45 jacks for voice (where needed). Label the wall plate with the Type (V-Voice, D-Data) and the next sequential station number from the 66 style punch block and patch panel. These station wires shall be terminated in the jack assembly following the standard Category 6 568B 100BaseT configuration for data and standard color configuration for voice. All station wires shall be certified, tested and clearly labeled at both ends with the station number.

If bid specifies modular offices, the installation shall include at least one (1) station wire runs (one 4- pair data line) to each modular office location. All pairs from the station wires shall be terminated in each modular office on a quad wall plate using orange RJ45 jacks for data drops and blue RJ45 jacks for voice drops (where needed). Label the wall plate with the Type (V-Voice, D-Data) and the next sequential station number from the 66 style punch block and patch

panel. These station wires shall be terminated in the jack assembly following the standard Category 6 568B 100BaseT configuration for data and standard color configuration for voice. All station wires shall be certified, tested and clearly labeled at both ends with the station number.

Additional station wire locations not specified in this section shall be indicated on blueprint as to their termination points. These station wires shall be installed equivalent to those in the permanent and modular office locations. These station wires shall meet the same requirements as stated.

Station wires shall be home runs from the wall jack location to the telecommunications network/server room. There shall be two (2) feet of slack in the cable at the office end. Slack cable shall be pulled and suspended into the ceiling when installing the wall jack assembly. In addition, each data location shall require a 10' RJ45 to RJ45 Category 6 patch cable.

All data station wires will be terminated following the standard 568A configuration on 48-port RJ45 110 Category 6-Certified patch panels which will be rack mounted. Rack(s) to be provided by Awarded Bidder, 42U 19"server rack frame 7' height, 4-post open rack in the building network/server room. Please Note: 5'and 3' RJ45 to RJ45 Category 6 patch cables will also be provided by Awarded Bidder at each termination point to allow for connection to agency owned network/server equipment.

If voice lines are required, they will terminate on 66 style punch blocks with all pairs punched down and mounted on backboards located in the building's telecommunications equipment room. The Department will provide phone sets, and telephone equipment.

All terminations shall be in accordance with standard telephone practices for color-coding. The arrangement of station connecting blocks and cables will be in a manner that reflects good workmanship and practices. All station wires shall be certified, tested and clearly labeled at both ends with the station number. All station wires shall be placed in ceiling using wire management system components to ensure that all wire runs are grouped and suspended throughout their destination.

Cable installed in ceiling spaces shall be UL listed as to type CMP or UL classified as to having adequate fire-resistance and low-smoke producing characteristics per NEC Article 800-3(B)(2). Any cable run which enters masonry and/or masonry walls shall be in 1/2 inch conduit. Any cable run penetrating a fire wall shall be in conduit and packed with fire stop caulking, according to local fire codes. All conduit ends shall have plastic end caps to guard against sharp edges. All cable runs shall be continuous. No splices of cable shall be allowed.

### **Telecommunications Equipment Room**

There shall be tile floor communication room designated for both voice and data communications. The telephone Company entrance cable shall be terminated in the communications room and extended to a 100 style punch block.

There shall be at least a 25-pair copper cable (protected) and a single mode fiber cable. One duplex receptacle 120 volt 15 amp single pole 3 wire isolated ground (NEMA 5-15R-IR) is required for the telephone equipment and should be on a separate breaker.

One #6 AWG ground wire solid copper insulated and bonded to the building ground electrode or ground window has to be provided in the communications room.

Provide two (2) quadruplet receptacles 120 volt 20 amp on each wall of this room.

The WAN demark shall be extended to the communications room.

All of the electric circuits in this room should have isolated ground, orange outlets.

A minimum light intensity level of 70-foot candles is requested for this room.

In addition, one quadruple 120 volts 20 amp receptacle shall be mounted on each data equipment rack. (Quantity of racks to be determined).

The entry into the room shall be through a locked and vented door at least 36 inches wide and shall only be accessible from the leased area. The communications room shall be served by a dedicated HVAC system, to be dust free and shall be in a location where electromagnetic interference is minimal to ensure a controlled environment.

Maximum heat dissipation for the telephone system is 1000 BTU/hr. For data, maximum heat dissipation is 1500 BTU/hr.

In the communications room there shall be a plywood backboard, 4 x 8 feet by 3/4 inches mounted on the longest unobstructed wall 36" above floor level. The plywood shall be affixed in such a manner that it will support the weight of the cable, terminals and other equipment that will be attached to it. The plywood backboard shall be treated with fire retardant material.

Awarded Bidder shall provide two (2) electronic rack systems, plus two (2) equipment shelves and wire management harnesses, for the Department's communication equipment. Rack shall be AMP-559260-1, 19" x 7' or equivalent. Rack shall be bolted to the floor after the equipment is installed in the building communications room.

**Note:** Locations offering multiple floors or in multiple buildings, one or more additional equipment rooms may be required although the size of the room shall be 10' x 12'. Where multiple communications rooms are more than 300 feet apart the Landlord shall provide multi-mode fiber optic (62.5/125) cable from the Main Distribution Frame to each Intermediate Distribution Frame. All fiber to be either Seicor or Lucent Technology, or equivalent with ceramic ST connectors. Fiber shall be no less than 12 strands. It will be the responsibility of the Landlord to provide cable risers to the multiple floor area locations for both telephone and computer lines.

**Janitorial Services:** The successful proposer agrees to furnish janitorial and cleaning services as part of this lease agreement. This includes furnishing all cleaning/maintenance equipment and cleaning supplies as required, including but not limited to drinking cups at water fountains, bathroom tissues, paper towels, trash receptacle liners, sanitary napkin disposal bags, toilet seat covers, liquid soap and doormats(weekly service is required) at entrances and exits.. All supplies are to be of good quality suitable for lessee's needs.

**Window Covering –Existing:** Exterior windows shall have blinds or shades to facilitate sunlight and energy control. Windows receiving direct sunlight shall be tinted or covered with energy saving film.



**Floor Coverings:** New carpeting will be installed prior to acceptance of the building. All individual office spaces and conference rooms shall have at least 26 face weight loop commercial grade anti-soil carpeting to benefit acoustics, comfort and minimum maintenance in cleaning. **Lounge/Break Room areas, reception areas, entrance, exits and restrooms will be ceramic tiled.** Carpeting shall have UM-44D, ASTM D 3674-81 /UM-44D, fire and 3.5 kilovolts electrostatic conductivity rating. All vinyl and carpeting shall be a color and by a manufacturer acceptable to the department, which will choose from an assortment of at least three samples provided by the lessor. Carpeting shall be treated to reduce staining.

Weekly floor mat service is required; mats are to be placed at all entrances and exits.

**Maintenance and Repair:** On or about every annual anniversary of the date of occupancy, a maintenance inspection will be conducted by the facilities services manager and the lessor or his representative to review the condition of the building interior, exterior and site. Any discrepancies will be noted and a date of correction completion established. During the term of the lease, if maintenance and repair items appear that are emergencies or recurring problems that have not received attention within three working days, the lessee will have the right to complete the work, by a contractor of lessor's choice, and send the invoice to the lessor for payment. Non-responsiveness shall be deemed a breach of this lease. Failure by the lessor to correct or repair documented interior problems within 60 days after written notification by the lessee shall result in further legal action to obtain compliance. **If** the lessee is successful in court, the lessor agrees to pay any and all attorney's fees of the lessee, as well as impact costs due to decreased productivity.

#### **Interior identification:**

Lessor will provide interior main directory showing location of all programs, conference rooms, etc. Provide directory signs on each floor and in entrance suites showing programs and/ or room use. Provide directional signs as required. Other ADA compliance, raised letter signs with Braille shall be provided to identify all restrooms (handicap symbol on restrooms for person with disabilities), conference rooms, mechanical equipment, and other special use rooms. All rooms and/or offices are to be numbered consecutively.

#### **Exterior identification:**

The department shall have the option to require department signage on the building exterior to be provided by the lessor either at the top of the building or at the entrance. Lessor is to provide vinyl lettering on all entrance doors to designate program(s).

**Note:** All signs must meet requirements of DCA/ADA Accessibility Requirements Manual, and are to be maintained by lessor.

### Security Requirements

- All outside doors shall be equipped with dead bolt or dead-latch locks and panic hardware.
- All interior office doors shall have key lockable locksets, turn-latch or push button on backside, master keyed. Specific locations of these locks will be assigned by DCF Program Administrator upon space-planning. If there are no common area restrooms in the building, all restrooms must also have lockable locksets.
- All opening outside windows shall have interior locks.
- Night illumination is required at all outside doors and all parking areas (minimum of 2 foot-candles) from dusk until dawn weekdays and weekends.
- Provide keys to all locksets in accordance with a master keying system acceptable to the department. Provide 4 master entrance keys.
- Doors leading from the reception area into the office area must be secured and equipped with both keycard access and a buzzer-like entry system to be controlled by the reception staff.

**Fire Prevention:** Lessor shall conform to all requirements of the State Fire Marshal and shall obtain pre-occupancy inspection and annual inspections by the State Fire Marshal as required by 633.085, Florida Statutes.

**Heating, Ventilation and Air Conditioning:** Provide sufficient climate control units with adequate ductwork, registers and grills sufficient to uniformly cool and heat the entire leased area. Unit(s) shall be equipped with **remote sensors and with digital type thermostat controls in a (lockable room, NA)** with color coded by zone mechanical plan placed on wall and laminated (This can be in the data/ phone room). Temperatures will be maintained to achieve an average zone temperature of 75 degrees Fahrenheit. Control thermostats will be located in areas to achieve proper zone temperature.

**LAN room for data/phone must be cooled to 75 degrees Fahrenheit at all times (requires separate AC unit to maintain 75 degrees Fahrenheit).**

**Occupancy:** The date of lease payment commencement will be determined by the date a Certificate of Occupancy is issued and final acceptance by the State Fire Marshal. In addition, the following criteria have been met:

- All installations are operational and complete;
- A letter of acceptance has been signed by the Issuing Officer.

Fire Prevention- Lessor shall conform to all requirements of the State Fire Marshal and shall obtain pre-occupancy inspection and annual inspections by the State Fire Marshal as required by 633.085, Florida Statutes.

### SAMPLE EVALUATORS EVALUATION CRITERIA FORM

<p><b>Criterion 3 - Location:</b> The effect of the facility’s location on the efficient and economical conduct of Agency operations planned for the requested space.                  Proximity of facility to the department’s preferred area, intersection of Interstate 95 and Palm Bay Road.</p> <p>A: Within 1 up to 5 mile radius <span style="float: right;"><u>10 pts</u></span></p> <p>B: More than 5 up to Ten 7 mile radius <span style="float: right;"><u>5 pts</u></span></p> <p>C: More than 7 and up to 10 mile radius <span style="float: right;"><u>3 pts</u></span></p> <p>D: More than a 10 mile radius <span style="float: right;"><u>0 pts</u></span></p> <p style="text-align: right;"><b>Maximum points: <u>10</u></b></p>	
<p><b>Criterion 4 - Parking:</b> The Department needs <b>60</b> parking spaces.</p> <p>A. Exclusive contiguous parking adjacent to the building <span style="float: right;"><u>10 pts</u></span></p> <p>B. Non-Exclusive or non-contiguous parking adjacent to the building <span style="float: right;"><u>8 pts</u></span></p> <p>C. Exclusive or non-exclusive, contiguous or non-contiguous parking onsite <span style="float: right;"><u>6 pts</u></span></p> <p>D. Exclusive offsite parking <span style="float: right;"><u>3 pts</u></span></p> <p>E. Non exclusive offsite parking <span style="float: right;"><u>0 pts</u></span></p> <p style="text-align: right;"><b>Maximum points <u>10</u></b></p>	
<p><b>Criterion 5 - Distance of the offered space from public transportation:</b></p> <p>A: Within zero (0) to two tenth (0.2) mile radius <span style="float: right;"><u>3 pts</u></span></p> <p>B: More than two tenth (0.2) up to four tenth (0.4) mile radius <span style="float: right;"><u>2 pts</u></span></p> <p>C: More than four tenth (0.4) up to five tenth (0.5) mile radius <span style="float: right;"><u>1 pt</u></span></p> <p>D: More than five tenth (0.5) mile radius <span style="float: right;"><u>0 pts</u></span></p> <p style="text-align: right;"><b>Maximum points: <u>3</u></b></p>	
<p><b>Criterion 6: Facility present condition- proximity to a physical plant, (including the physical characteristics of the building and the property the building sits on, adjacent structures and surrounding neighborhood.</b> Each question below will receive 1 point if the answer is “yes” or 0 points if the answer is “no”.</p> <p>A. Are there good transportation links?</p> <p>B. Are there amenities (gas stations, restaurants, convenience stores, etc.) sufficient to meet the needs of the occupants of the Proposed Space?</p> <p>C. Does the building have a security system relatively adequate to protect the persons and property of the occupants of the proposed space?</p> <p>D. Is the building well-maintained?</p> <p>E. Are the surrounding properties, buildings, streets and sidewalks relatively well maintained, free from debris and visible evidence that the properties or buildings are in violation of any law, ordinance, rule or regulation, and any enforcement proceedings relating thereto, or are being used for any unlawful purpose</p> <p style="text-align: right;"><b>Maximum points: <u>5</u></b></p>	
<p><b>Criterion 7: Security issues posed by the building, associated parking and surrounding neighborhood, as evidenced by police reports, quality of exterior lighting and obstructed entrances/exits.</b> Each question below will receive 1 point if the answer is “yes” or 0 points if the answer is “no”.</p> <p>A. Are there perimeter controls such as gates, fences, walls, landscaping, etc. that restricts access to the property?</p> <p>B. Are the parking lots well marked and well lit at night?</p> <p>C. Are the sidewalks and walk ways unshrouded by over growth and easily seen and are there no hidden alley ways, access routes or hiding places?</p> <p>D. Are there amenities present (lighting, patrolled hallways and parking areas, escorted ingress/egress, etc.) that aid after hour access and operation?</p> <p>E. Do the police reports indicate that the Proposed Space is Located in a relatively safe neighborhood?</p> <p style="text-align: right;"><b>Maximum points: <u>5</u></b></p>	

<p><b>Criterion 8: The extent to which the offered space is designed for efficient layout and good utilization of space and energy</b> (for example house service units in proximity to interdependent units, Sustainable building Rating or E.A. Energy Rating). Each question below will receive 1 points if the answer is “yes” or 0 points if the answer is “no”.</p> <p>A. Is the offered space in a square shaped building and not a building that is in the shape of a rectangular or any other shape? _____</p> <p>B. Is the present configuration of the offered space in an open plan that requires a lower tenant improvement cost? _____</p> <p style="text-align: right;"><b>Maximum points: 2</b></p>													
<p><b>Criterion 9: The contiguity of the offered space</b> (providing the aggregate square footage in a single building on a single floor is preferred):</p> <p>A: Aggregate space in a single building, single floor on a first story. <b>10 pts</b></p> <p>B: Aggregate space in a single building, on two or more floors or upper floor <b>5 pts</b></p> <p>C: Aggregate space in two buildings, connected by sidewalks/overhangs, on a single floor <b>2 pts</b></p> <p>D. Aggregate space in two buildings, connected by sidewalks/overhangs, on two or more floors <b>1 pt</b></p> <p>E. Aggregate space in two buildings, not connected by sidewalks/overhangs or aggregate space in three or more buildings <b>0 pts</b></p> <p style="text-align: right;"><b>Maximum points: 10</b></p>													
<p><b>Criterion 10: Building BOMA Rating</b> (At time of submittal):</p> <table style="width: 100%; border: none;"> <tr> <td style="width: 30%;">Class A-</td> <td>A Building = <b>4 pts</b></td> <td></td> </tr> <tr> <td>Class B-</td> <td>B Building = <b>3 pts</b></td> <td></td> </tr> <tr> <td>Class C -</td> <td>C Building = <b>2 pts</b></td> <td></td> </tr> <tr> <td>Class D -</td> <td>D Building = <b>0 pts</b></td> <td style="text-align: right;"><b>Maximum points: 4</b></td> </tr> </table>	Class A-	A Building = <b>4 pts</b>		Class B-	B Building = <b>3 pts</b>		Class C -	C Building = <b>2 pts</b>		Class D -	D Building = <b>0 pts</b>	<b>Maximum points: 4</b>	
Class A-	A Building = <b>4 pts</b>												
Class B-	B Building = <b>3 pts</b>												
Class C -	C Building = <b>2 pts</b>												
Class D -	D Building = <b>0 pts</b>	<b>Maximum points: 4</b>											
<p><b>Criterion 11: The proximity of the proposed facility in relation to our community partners and available space to accommodate expansion</b> (A community partner is a lead community-based care agency or one of more its subcontracted providers of foster care and related services as defined and/or contemplated in §409.1671, FS.).</p> <p>Each question below will receive 2 points if the answer is “yes” or 0 points if the answer is “no”.</p> <p>A. Is there sufficient space for future expansion? _____</p> <p>B. Is there sufficient space to accommodate our Community Partners (5,000 +/- SF)? _____</p> <p>C. Is the proximity of the proposed location within 3 miles of our community partners? _____</p> <p style="text-align: right;"><b>Maximum points: 6</b></p>													
<p><b>Criterion 1 - Rental rates per square foot for basic term of lease:</b> Rental rates evaluated, using total present value methodology for basic term of lease, by application of the present value discount rate of .78 .</p> <p style="text-align: right;"><b>Maximum points: 30</b></p>													
<p><b>Criterion 2 - Rental rates per square foot for optional renewal terms of lease:</b> Rates evaluated, using total present value methodology for renewal terms of lease, by application of the present value discount rate of ____%.</p> <p style="text-align: right;"><b>Maximum points: 15</b></p>													
<p>(Total Possible =100) <b>TOTAL WEIGHTED SCORE:</b></p>													
<p><b>Attestation of Conflict of Interest</b></p>													
<p>I, _____(Name), _____(Title), hereby certify that while I have taken part in the development or selection of criteria for evaluation, in the evaluation, and/or in the award processes forth above referenced lease, I am independent of and have no conflict of interest in the entities evaluated and selected.</p>													
<p>Evaluator Signature:</p>	<p>Date:</p>												

EVALUATOR NAME :						
EVALUATION CRITERIA SUMMARY		Points	Proposer A	Proposer B	Proposer C	Proposer D
<b>Criterion 3: Location</b>						
A: Within 0 up to 1 mile radius	10					
B: More than 1 up to 2.5 mile radius	5					
C: More than 2.5 and up to 5 mile radius	3					
D: More than a 5 mile radius	0					
<b>Criterion 4: Parking</b>						
A: Exclusive, contiguous, adjacent to the building	10					
B: Non-Exclusive or non-contiguous, adjacent to building	8					
C: Exclusive or non-exclusive, contiguous onsite	6					
D: Exclusive offsite parking	3					
E: Non exclusive offsite parking	0					
<b>Criterion 5: Public transportation</b>						
A: Within zero (0) to two tenth (0.2) mile radius	5					
B: More than two tenth (0.2) up to four tenth (0.4) mile radius	2					
C: More than four tenth (0.4) up to five tenth (0.5) mile radius	1					
D: More than five tenth (0.5) mile radius	0					
<b>Criterion 6: Facility Present Condition</b>						
A. Transportation	1					
B. Amenities	2					
C. Security system adequate	2					
D. Well-maintained building	2					
E. Property surrounding	2					
<b>Criterion 7: Security</b>						
A. Are there perimeter controls	1					
B. Parking well marked and well lit at night	1					
C. Sidewalks and walk ways unenshrouded	1					
D. Amenities present to aid after hour access and operation	1					
E. Proposed Space in a relatively safe neighborhood	1					
<b>Criterion 8: Space efficient layout</b>						
A. Rectangular shaped building	1					
B. Present configuration that requires a lower TI	1					
<b>Criterion 9: Contiguity</b>						
A: Single building, single floor on a first story	10					
B: Single building, on two or more floors	5					
C: Two buildings, connected one floor	2					
D: Two buildings, connected on two or more floors	1					
E: Two or more buildings, not connected	0					
<b>Criterion 10: BOMA Rating</b>						
A: Class A	4					
B: Class B	3					
C: Class C	2					
D: Class D	0					
<b>Criterion 1: Base Rate</b>	30					
<b>Criterion 2: Option Rental Rate</b>	15					
<b>TOTAL POINTS:</b>			0	0	0	0

## Chapter 7

## STAY-IN-PLACE

- Legislative Session 2001 approved SB 850 that amended s.255.25, FS, authorizing state agencies to execute replacement leases. This bill is better known as "Stay-In-Place" that allows the agency to negotiate replacement leases, over 5,000 square feet, with the current landlord under certain conditions.
  - FS 225.25.3a(c) The department may approve extensions of an existing lease of 5,000 square feet or more of space if such extensions are determined to be in the best interests of the state, but in no case shall the total of such extensions exceed 11 months. If at the end of the 11th month an agency still needs that space, it shall be procured by competitive bid in accordance with s. 255.249(4)(b). However, an agency that determines that it is in its best interest to remain in the space it currently occupies may negotiate a replacement lease with the lessor if an independent comparative market analysis demonstrates that the rates offered are within market rates for the space and the cost of the new lease does not exceed the cost of a comparable lease plus documented moving costs. A present-value analysis and the consumer price index shall be used in the calculation of lease costs. The term of the replacement lease may not exceed the base term of the expiring lease.
- Eligible Leases
  - Any active lease where the Lessor can show control of the property for the new rental period.
- Time Frames
  - Agency wishing to negotiate to stay in place under the provisions established by FS 225.25.3a(c) will start the process eighteen, (18), months in advance from the expiration date of the lease in question. If the Region is unable to negotiate a suitable contract to meet the department needs, the Region must procure the replacement lease through the competitive bidding process as outlined by the DMS and pursuant the F.S. 255.25
- Independent Market Analysis
  - The Region must contact the Tennant Broker for an independent market analysis, (IMA).
  - The analysis must contain market information on like properties and will project the market trend, which will forecast a competitive rate for the term of the renegotiated lease.
- Length of Term

The term of any lease negotiation under FS 225.25.3a(c) will not exceed the length of the base period of the original lease. Therefore, no renewal options are allowed.

## PROCEDURES TO NEGOTIATE

## A "STAY-IN-PLACE" (SIP)

- Contact a Tenant Broker for a description of the market condition and an independent market analysis of like spaces in the area for a period not to exceed the base term of current lease.
  - The IMA should help to decide between a SIP or new procurement.
- Submit to Central Office:
  - A DRSN for a "New Lease", outlining the term required with no renewals. (Where possible this process should be started at least 18 months in advance of the expiration of current lease).
  - Memo to Central Office and DMS outlining the benefits of the lease action.
  - A checklist that describes the nature of the lease action
- When Central Office approves the DRSN, the request will be forwarded to DMS.
- Upon receipt of the approved RSN from DMS,
  - Region or Tenant Broker will contact the Lessor for a proposal on the term outlined in the RSN, including a list of any upgrades or renovations required with the new lease.
  - Upon receipt of the proposed rate from the Lessor review the offering,
    - Compare it to the market analysis by preparing a present value calculation (PVC), including moving cost and decide which direction best suits the department needs.
    - Prepare a "Stay in Place Benefit Analysis Worksheet" located at DMS Website

[Lease Forms / Leasing Procurement / Bureau of Property Services / Real Estate Development and Management / Business Operations - Florida Department of Management Services \(myflorida.com\)](#)

Note: In the event that the agency decides not to accept the proposal from the landlord, the Region will need a new DRSN to proceed with the normal procurement process. (See Chapter 5)

- If the Region decides to remain in the existing space under a SIP lease prepare the following lease documents should be prepared (prepared by TB; if engaged) and send to DMS and via Memo Tracker to ASG, Program Director, HQ Budget, General Counsel for review and pre-approval:
  - Lease Agreement Form 4054, and all addenda.
  - Disclosure Statement Form 4114.
  - Certificate of Compliance Form 4113
  - Independent Market Analysis (IMA)
  - Present Value Calculations
  - Stay in Place Benefit Analysis Worksheet
- Once approved by DMS and Central Office, send the following documents to the Lessor for signature:
  - Lease Agreement, and all addenda.
  - Disclosure Statement Form 4114.
  - Tenant Broker Agreement
- Upon receiving documents from Lessor review that documents were signed and initialed in the designated areas, forward to the ASG for General Legal Counsel and Assistant Secretary of Administration for review and signature.



- Then prepare the lease transmittal form and attach the following documents:
  - Lease Agreement and addenda
  - Disclosure Statement
  - Executed Commission Agreement (tenant broker to provide)
  - Energy Performance Analysis (tenant broker to provide)
  - Tenant Improvement Cost Breakdown (completed by tenant broker)
  - Tenant Broker Evaluation Worksheet
- Upon receiving the final approval letter, (FA), from DMS, verify that all documents are in the leasing file:
  - Lease Agreement
  - Certificate of Compliance
  - Disclosure Statement
  - Market Analysis
  - Quote submitted
  - Present Value calculation
  - Acceptance Letter
  - Handicap Checklist
  - SFM approving plans (if applicable)
  - Floor Plans
- Send the following to Lessor:
  - Lease Agreement and all addendum
  - DMS final approval letter
- Send the following to Central Office:
  - CARS Form
  - New lease Encumbrance
  - FA letter and lease documents
  - Original Lease Document to ASSC Lease Payments
- The lease process is completed.

PLEASE REVIEW COMMENTS IN CELLS DENOTED WITH THE RED TRIANGLE IN THE TOP RIGHT CORNER FOR MORE DETAILS.

<b>AGENCY:</b>		<b>CURRENT LEASE #</b>		
----------------	--	------------------------	--	--

MARKET LEASE DATA						MARKET LEASE ASSUMPTIONS					
SF	FTE	Rate	Rate Includes	Janitorial Rate	Utility Rate						

MARKET ANTICIPATED OUT YEAR ESTIMATES						MARKET ANTICIPATED ANNUAL OPERATION COSTS					
Full Service Annual Rent (FY 20xx-xx)	(FY 20xx-xx)	(FY 20xx-xx)	(FY 20xx-xx)	(FY 20xx-xx)	FY 20xx-xx Subtotals	Special Equipment	Data	Communications	Office Equipment	Moving Costs	Anticipated Operation Costs Sub-Total
\$0	\$0	\$0	\$0	\$0	\$0						\$0

* SQUARE FOOT ANALYSIS		
Market	SIP	Difference
0	0	0

* SQUARE FOOT PER FTE ANALYSIS		
Market	SIP	Difference
#DIV/0!	#DIV/0!	#DIV/0!

STAY-IN-PLACE CO-LOCATION OPTION							SIP ASSUMPTIONS				
SF	FTE	Anticipated Procurement Date	Rate	Rate Includes	Janitorial Rate	Utility Rate					

SIP ANTICIPATED OUT YEAR ESTIMATES						SIP ANTICIPATED OPERATION COSTS					
Full Service Annual Rent (FY 20xx-xx)	(FY 20xx-xx)	(FY 20xx-xx)	(FY 20xx-xx)	(FY 20xx-xx)	FY 20xx-xx Subtotals	Special Equipment	Data	Communications	Office Equipment	Other	Sub-Total
\$0	\$0	\$0	\$0	\$0	\$0						\$0

* COST-BENEFIT SUMMARY FIVE YEAR LOOK										
LEASE COSTS				OPERATIONAL COSTS				FINAL ANALYSIS		
	MARKET	SIP	DIFFERENCE		MARKET	SIP	DIFFERENCE		\$ DIFFERENCE	
YEAR 1	\$0	\$0	\$0		\$0	\$0	\$0		YEAR 1	\$0
YEAR 2	\$0	\$0	\$0		\$0	\$0	\$0		YEAR 2	\$0
YEAR 3	\$0	\$0	\$0		\$0	\$0	\$0		YEAR 3	\$0
YEAR 4	\$0	\$0	\$0		\$0	\$0	\$0		YEAR 4	\$0
YEAR 5	\$0	\$0	\$0		\$0	\$0	\$0		YEAR 5	\$0
	<b>TOTALS</b>	<b>\$0</b>	<b>\$0</b>		<b>\$0</b>	<b>\$0</b>	<b>\$0</b>		<b>TOTAL ESTIMATED REDUCTIONS</b>	<b>\$0</b>

## Chapter 8

### Lease modifications

As changes happen in program needs, budgets, and the economy, our need for office space changes as well and the leases can be modified to reflect these changes. The modification form FM 4063 can be used to make the changes after RSN approval is obtain from DMS.

#### General

- A lease Modification to Increase Space can be exercised as needed however the aggregate square footage can't exceed 4,999 square foot in a twelve-month period per lease or complex.
  - Leases acquired by lease negotiations or Quote, can be modified only after twelve months from the enter into date of the lease agreement.
    - The twelve-month period is calculated from the enter to date of the original lease or previous lease modification.
    - Leases acquired by the competitive procurement process can be modified any time after the original lease is approved.
  - The Modification is under the same terms and conditions as the original lease.
- A lease Modification to Reduce square footage can be exercised anytime, providing the lessor agrees to relieve the state from the lease obligations. If the lessor is not agreeable, other staff should be identified to occupy the vacant space.
- A lease Modification to Change Description is used to correct wrong information entered to the original lease or when an office is moved within the same facility or complex.
  - If the Lessor request the relocation, the Lessor will be responsible for all relocating costs, unless the move is requested by the agency and is in the best interest of the state.
- A lease Modification to Decrease the rental rate may be executed at any time the lessor is agreeable.
  - Reduction in rate must be under the same terms and conditions of the original lease.
  - Reduction of services from the original lease should not be a condition for the rate reduction.
  - Rental rate reduction is commonly achieved when the lease is up for renewal.
- Section III, of the 1993 Appropriation Act, allows agencies to negotiate rental rate adjustments by exercising early renewal options and/or extending the term, in exchange for reducing rental rate(s) for the basic Lease, renewal periods or a combination of both.
- A Modification to Increase Rental Rate for a facility may be executed only if conditions warrant and receive prior approval by the Department of Management Services. Reasons for entering into a modification to increase the rental rate must be well documented.
- Lease Modification to Change the Effective Date and Extend Term, is exercised if occupancy of the facility is more than one month after the effective date of the original lease.

- Leases over or under 5,000 square feet may be modified to extend the term on a month-to-month basis for a period not to exceed eleven months.

A lease may only be extended upon the same terms and conditions of the original lease. An increase in rental rate cannot be approved for an extension period.

## PROCESS

1. The Region determines there is a need to modify the lease. This is the time to look at long term planning for future growth, client demographics and facility condition.
2. Once leasing need has been determined, facilities services manager office requests an updated Program Request SAW.
3. Prepare the DRSN and obtain the approval signatures.
4. Send electronically to Central Office the following:
  - Signed DRSN by Program Manager and Budget
  - Program Request SAW, and DMS SAW.
  - Justification that describes the nature of the lease action and the impact of this action on the leasing/budget.
5. Once the RSN is approved by DMS, begin a lease file with all the information available.
6. Contact Tenant Broker, (If engaged), to describe the program needs and department expectations.
  - a. If tenant broker is not being used, then the Facilities Services Manager, (FSM), should contact the Lessor to negotiate all the program needs.
7. When increasing/decreasing space with renovations, coordinate with the Program and Lessor to begin space planning and identify the timeline for renovations and determine the effective day of the modification.
  - If renovations are required State Fire Marshal (SFM) inspections are required.
  - If renovations are not required, the SFM inspection is needed to verify that life safety condition has not changed.
1. The following lease documents should be prepared (prepared by TB; if engaged) and send it to DMS and via Memo Tracker to ASG, Program Director, HQ Budget, General Counsel for review and pre-approval:
  - DMS Lease action Checklist
  - Signed Certificate of Compliance Form 4113.
  - Unexecuted Lease Modification, and all addenda.
  - Unexecuted Updated Disclosure Statement Form 4114A.
  - Market Survey (IMA)

*DMS Forms found at:*

[Lease Forms / Leasing Procurement / Bureau of Property Services / Real Estate Development and Management / Business Operations - Florida Department of Management Services \(myflorida.com\)](#)

8. Once DMS and Tracker Memo is approved, email the following to the Lessor:
  - DMS pre-approved Modification with all addenda.
  - DMS pre-approved Updated Disclosure Statement
  - Employment Eligibility Verification (E-Verify)
  - Commission Agreement (already signed by Tenant Broker)
  
9. Upon return of the lease documents from the Lessor, all documents are sent to ASG:
  
11. Upon return of the documents from the ASG, send the following to DMS for final approval:
  - Lease Action Checklist
  - Executed Modifications
  - Executed Employment Eligibility Verification (E-Verify) – (If applicable)
  - Executed Updated Disclosure Statement
  - SFM Approval Letter, if applicable
  - Floor Plans (if applicable)
  - Tenant Broker Evaluation Worksheet (If engaged)
  - Executed Commission Agreement (If engaged)
  
12. Keep track of renovations, if applicable, to assure occupancy date is achieved.
  
13. Prior to occupancy of space, the following must be done:
  - A physical measurement of increase/decrease in space, if applicable.
  - Complete the Handicap Accessibility Checklist, if applicable.
  - If renovations were done, a Certificate of Occupancy must be provided.
  - State Fire Marshal must perform the 60% and 100% final inspection on increased/decreased space with renovations. If no renovations, SFM site inspection is recommended.
  
14. Upon receipt of DMS approval, send the following electronically documents Lessor:
  - Final DMS Approval Letter
  - Modification
  
15. Send the following electronically documents to ASG:
 

Final DMS Approval Letter  
Modification
  
16. The following documents must be in Leasing File:
 

<ul style="list-style-type: none"> <li>DMS Final Approved Letter</li> <li>Certificate of Compliance</li> <li>Approved RSN</li> <li>Program Request form</li> <li>Floor plans, if applicable</li> <li>Lease Justification</li> </ul>	<ul style="list-style-type: none"> <li>Modification</li> <li>Updated Disclosure Statement</li> <li>DMS Prior-Approval Letter</li> <li>DMS SAW</li> <li>SFM Approval Letter</li> </ul>
---	---
  
17. Lease action is completed.



**State of Florida  
Department of Children and**

**XXXXXXXXXX**  
*Governor*

**XXXXXXXXXX**  
*Secretary*

**MEMORANDUM**

**DATE:**

**TO:** \_\_\_\_\_, Assistant Secretary for Administration

**FROM:** \_\_\_\_\_, Regional General Services Manager

**SUBJECT:** Prior Approval of Lease Number 590:XXXX

**ROUTING:**

**General Services:** \_\_\_\_\_  
, Leasing Coordinator

**ASG General Services:** \_\_\_\_\_  
, Staff Director of General Services

**HQ Financial Management:** \_\_\_\_\_ **(if cost increase)**  
**Budget** \_\_\_\_\_, Budget Manager

**Program Director:** \_\_\_\_\_  
, Program Director

**HQ General Counsel:** \_\_\_\_\_  
, General Counsel

**APPROVAL:** \_\_\_\_\_  
, Assistant Secretary for Administration

**PURPOSE:**

**BACKGROUND:**

**ACTION REQUESTED:**

***Mission: Work in Partnership with Local Communities to Protect the Vulnerable, Promote Strong and Economically Self-Sufficient Families, and Advance Personal and Family Recovery and Resiliency***

# Agency Review Checklist

## Lease Modifications

<b>TRIRIGA ID:</b>			
<b>LEASE NUMBER:</b>		<b>SQUARE FOOTAGE:</b>	<b>MOD. NO.:</b>
<b>LOCATION:</b>		<b>EFFECTIVE DATE:</b>	
<b>ACTION DESCRIPTION:</b>			
<b>AGENCY:</b>		<b>AGENCY LEASE LIAISON:</b>	<b>TENANT BROKER:</b>
<b>DMS LEASE SPECIALIST:</b>			

**REQUEST FOR SPACE NEEDED (RSN) APPROVAL**  
**TRIRIGA**

- Check Adversely Affected Lessors/Excess Space <sup>(1)</sup>** (Current list on DMS Pre-approved Forms Website)
- Check for State-Owned Space <sup>(2)</sup>** (If available, not suitable for needs acknowledgment must be provided)
- Request must match Agency's Annual Data Gathering Plan** (Submit update via email if necessary)
- Submit RSN in TRIRIGA** (Please complete ALL fields)
- Space Allocation Worksheet (SAW) FM-4100 <sup>(3)</sup>**
- If increasing FTE, provide documentation/justification <sup>(4)</sup>**

**PRIOR APPROVAL**

- Certification of Compliance FM-4113** (Authorized Signature Required)
- Unexecuted Lease Documents** (e.g. Agreement for Modification FM-4054)
- Unexecuted Disclosure Statement FM-4114 or Updated Disclosure Statement FM-4114A <sup>(5)</sup>**  
(Not required for change of address)
- Employment Eligibility Verification (E-VERIFY FORM) FM-4054K <sup>(6)</sup>**  
(Required for all Governor's Office directed agencies, pursuant to Executive Order 11-02)
- Market Rate Survey/ IMA** (Must be provided for all extensions, renewals and rate restructures)
- Compare Lease data to approved RSN**

**FINAL APPROVAL**

- Executed Lease Modification Documents** (Authorized Signature Required; "entered into" dates to be completed by DMS)
- Executed Disclosure Statement**
- Executed Tenant Broker Commission Agreement FM-4097**
- Tenant Broker Evaluation Worksheet** (DMS Pre-approved Lease Forms Website)
- Fire Marshal Approval <sup>(7)</sup>** (Must provide to DMS prior to occupancy)

<sup>(1)</sup> If space is available, justification must be provided as to why the space does not meet Agency needs  
<sup>(2)</sup> If state-owned space is available within the geographic region, Agency must justify the use of private space, see Chapter 60H-1.002(2)(c), F.A.C.  
<sup>(3)</sup> SAW and not required for modifications with no FTE or Sq. Ft. change  
<sup>(4)</sup> When increasing FTE, include the lease number indicating where they are coming from, provide language, or new agency position  
<sup>(5)</sup> Sections 1-3 must be completed with owner information on the disclosure statement  
<sup>(6)</sup> Not required if included in previous lease action  
<sup>(7)</sup> Applicable only if square footage increases or change in premises description per Section 255.25(5), Florida Statutes  
 \* Per Section 255.254(3)(c), Florida Statutes, the department may approve extensions of an existing lease of 5,000 sq. ft., but may not exceed 11 months.





# STATE OF FLORIDA Agreement for Modification

Bureau of Leasing, Department of Management Services Form 4040

Lease Number: \_\_\_\_\_

Modification Number: \_\_\_\_\_

WHEREAS, the \_\_\_\_\_, as Lessee, has previously entered into Lease Number \_\_\_\_\_, on \_\_\_\_\_, which became effective \_\_\_\_\_, and consists of \_\_\_\_\_ square feet; the current Lessor being \_\_\_\_\_;

and WHEREAS, the current description of the leased premises is:

\_\_\_\_\_

and the covenants and conditions contained in the original State of Florida, Department of Management Services' Lease Agreement, as amended by the below modification(s) are hereby readopted and incorporated herein.

1.  Agreement for Lease Renewal:

Lessor and Lessee agree that, pursuant to Article \_\_\_\_\_ of the Lease Agreement described above, the Lessee hereby exercises the option to renew Lease for a period of \_\_\_\_\_ year(s) beginning \_\_\_\_\_ and ending \_\_\_\_\_.

2.  Agreement for Lease Extension:

Lessor and Lessee hereby agree to extend the term of the Lease Agreement described above for a period of \_\_\_\_\_ month(s), beginning \_\_\_\_\_ and ending \_\_\_\_\_.

3.  Restructuring the Rental Rate:

Commencing \_\_\_\_\_, the Lease referenced above is amended to increase  or decrease  the rental rate per square foot per year paid to the Lessor by the Lessee to the amounts as specified in Article 8 of this agreement.

4.  Increase or Decrease Square Footage:

Commencing \_\_\_\_\_, the Lease referenced above is amended to increase  or decrease  the square footage leased under this Lease by \_\_\_\_\_ square feet from \_\_\_\_\_ square feet to \_\_\_\_\_ square feet. The description of added or deleted square footage is: \_\_\_\_\_ and the rental rates, pursuant to this change, shall be as specified in Article 8 of this Agreement.

5.  Change the Renewal Option Terms:

Commencing \_\_\_\_\_, the Lease is hereby amended to change the renewal option periods from \_\_\_\_\_, \_\_\_\_\_ year periods to \_\_\_\_\_, \_\_\_\_\_ year periods.

6.  Cooperation with the Inspector General:

Pursuant to section 20.055(5), Florida Statutes, contractor and any subcontractors understand and will comply with their duty to cooperate with the inspector general in any investigation, audit, inspection, review, or hearing.



# STATE OF FLORIDA Agreement for Modification

Bureau of Leasing, Department of Management Services Form 4040

Lease Number: \_\_\_\_\_

Modification Number: \_\_\_\_\_

7.  Other:

(Use this section to specify terms not included in the sections above. If this box is not selected, no additional modifications are included.)

8. Effective Rental Rates – Square Footage \_\_\_\_\_

Start (MM/DD/YYYY)	TERM		RATE PER SQUARE FOOT	MONTHLY RATE	ANNUAL RATE
		End (MM/DD/YYYY)			
	-			0	0
	-			0	0
	-			0	0
	-			0	0
	-			0	0
	-			0	0
	-			0	0
	-			0	0
	-			0	0
	-			0	0
	-			0	0

Agreement to Incorporate Addendum

WHEREAS, both the Lessor and the Lessee wish to amend and modify said lease so as to incorporate Addendum \_\_\_\_\_ effective \_\_\_\_\_, \_\_\_\_\_.

NOW, THEREFORE, in consideration of the mutual promises and covenants herein contained; the parties hereto hereby agree as follows:

Commencing \_\_\_\_\_, \_\_\_\_\_, said lease is hereby amended and modified to incorporate Addendum \_\_\_\_\_.



# STATE OF FLORIDA Agreement for Modification

Bureau of Leasing, Department of Management Services Form 4040

Lease Number: \_\_\_\_\_

Modification Number: \_\_\_\_\_

IN WITNESS WHEREOF, the parties hereto have hereunto executed this instrument for the purpose herein expressed, the \_\_\_\_\_, \_\_\_\_\_, \_\_\_\_\_.

ANY MODIFICATION OF A LEASE AGREEMENT SHALL NOT BECOME LEGALLY EFFECTIVE UNTIL APPROVED/ACCEPTED BY THE DEPARTMENT OF MANAGEMENT SERVICES.

*ORIGINAL SIGNATURES REQUESTED ON ALL COPIES*

As to Lessor – Lessor, or authorized representative and two witnesses must sign, print name and enter date.

X _____ Lessor or Authorized Representative	_____ Printed Name/Title	_____ Date
X _____ Witness #1	_____ Printed Name	_____ Date
X _____ Witness #2	_____ Printed Name	_____ Date

As to Lessee Agency – Agency head, or authorized delegate, and representative of Agency Office of General Counsel must sign, print name and enter date.

X _____ Agency Head or Authorized Delegate	_____ Printed Name/Title	_____ Date
X _____ Agency Office of General Counsel	_____ Printed Name	_____ Date

As to the Department of Management Services – Chief Real Property Administrator (or authorized designee) and Secretary (or authorized delegate) must sign, print name and enter date. When applicable, DMS Office of General Counsel shall sign, print name and enter date.

X _____ Chief Real Property Administrator	_____ Printed Name/Title	_____ Date
X _____ Secretary or Authorized	_____ Printed Name	_____ Date
X _____ DMS Office of General Counsel	_____ Printed Name	_____ Date

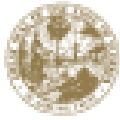

STATE OF FLORIDA  
DEPARTMENT OF MANAGEMENT SERVICES  
UPDATED DISCLOSURE STATEMENT

Lease Number:

Location:

The Disclosure of Ownership Statement, form FM 4114, currently on file dated , remains valid and correct.

Lessor:

(SEAL)

(x) \_\_\_\_\_  
Authorized Signature

\_\_\_\_\_  
Name/Title

Date



STATE OF FLORIDA  
DEPARTMENT OF MANAGEMENT SERVICES  
Employment Eligibility Verification

ADDENDUM

LEASE NUMBER:

Pursuant to Executive Order #11-02 (as Superseded by 11-116), Lessor agrees that it will enroll and participate in the Employment Eligibility Verification Program ("E-Verify Program") administered by the U.S. Department of Homeland Security ("DHS"), under the terms provided in the "Memorandum of Understanding" with DHS governing the program, to verify the employment eligibility of all persons it employs under the lease term to perform duties in Florida. Lessor further agrees to provide to the Lessee, as part of the leasing documents, documentation of such enrollment in the form of a copy of the "Edit Company Profile" page in E-Verify, which contains proof of enrollment in the E-Verify Program. (This page can be accessed from the "Edit Company Profile" link on the left navigation menu of the E-Verify employer's homepage.) Information regarding "E-Verify" is available at the following website: <http://www.uscis.gov/e-verify>.

Lessor further agrees that it will require each subcontractor that performs work under this lease to verify the employment eligibility of its employees hired during the term of this contract by enrolling and participating in the E-Verify Program within ninety days of the effective date of this lease or within ninety days of the effective date of the contract between the Lessor and the subcontractor, whichever is later. The Lessor shall obtain from the subcontractor(s) a copy of the "Edit Company Profile" screen indicating enrollment in the E-Verify Program and make such record(s) available to the Agency and other authorized state officials upon request.

Lessor further agrees to maintain records of its participation and compliance with the provisions of the E-Verify Program, including participation by its subcontractors as provided above, and to make such records available to the Agency and other authorized state officials upon request.

Compliance with the terms of this Employment Eligibility Verification provision (including compliance with the terms of the "Memorandum of Understanding" with DHS) is hereby made an express condition of this lease.

Lessee

Lessor

(x) \_\_\_\_\_

Lessee Signature

Name/Title

Date

(x) \_\_\_\_\_

Lessor Signature

Name/Title

Date

## Chapter 9

## Prior approval

A Prior-Approval is required from DMS and DCF HQ Administration before the lease documents are signed by the Lessor. The prior approval is accomplished by submitting electronically to DMS and HQ Administration via Tracker Memo, all documents used for determination of the lease action. The following documents are to be submitted:

## A. Renewal

- Certificate of Compliance FM-4113 – Signed by Staff Director of General Services
- Unexecuted Lease Modification, Notice of Renewal or Agreement for Renewal documents.
- Unexecuted Disclosure Statement FM-4114 or Updated Disclosure FM-4114A
- Employment Eligibility Verification, E-Verify FM-4054K
- Market Rate Survey ( Provided by Tenant Broker)

## B. Modification

- Certificate of Compliance FM-4113 – Signed by Staff Director of General Services
- Unexecuted Lease Agreement for Modification Documents FM-4040
- Unexecuted Disclosure Statement FM-4114 or Updated Disclosure Statement FM-4114A
- Employment Eligibility Verification (E-VERIFY FORM) FM-4054K
- Market Rate Survey/ IMA (Must be provided for all extensions, renewals and rate restructures)

## C. New Lease Under 5,000 square feet

- Certificate of Compliance FM-4113 – Signed by Staff Director of General Services
- Unexecuted Lease Agreement with all Addendum(s) FM-4054
- Unexecuted Disclosure Statement FM-4114
- Unexecuted Employment Eligibility Verification (E-VERIFY FORM) FM-4054K
- Blank procurement QSP package
- Three executed QSP responses packages
- Quote Synopsis FM-4137A (Must include justification for site selected and GSM signature)
- Net Present Value (NPV) Calculation
- Proof of Ownership (e.g. Recorded Deed)

## D. New Lease Over 5,000 square feet

- Certificate of Compliance FM-4113 – Signed by Staff Director of General Services
- Unexecuted Lease Agreement with all Addendum FM-4054
- Unexecuted Disclosure Statement FM-4114
- Unexecuted Employment Eligibility Verification (E-VERIFY FORM) FM-4054K
- Blank procurement RFP, ITB or ITN package
- All executed responses package

- Conflict of Interest Statements (completed by evaluation team)
- Bid Synopsis FM-4137 (Must include justification for site selected and GSM signature)
- Net Present Value (NPV) Calculation with BAFO rates
- Proof of Ownership (e.g. Recorded Deed)
- Tenant Improvement Cost Breakdown if Lessor Seeks Reimbursement
- Scaled Floor Plans

CERTIFICATION OF COMPLIANCE

By signing a Certification of Compliance, (Form 4113), the Staff Director of General Services attests that all leasing criteria under Administrative Code 60-H1 & 2 and F.S. 255.25 have been met for DMS Prior-Approval. An original Certification of Compliance is to be submitted with all new leases, modification or renew lease actions except for cancellations, change of ownership or change of payee.

INSTRUCTIONS FOR COMPLETING THE CERTIFICATION OF COMPLIANCE

1. (1) LEASE NUMBER Enter the lease number assigned by DMS on the RSN.
2. (2) DATE Enter the date that form is prepared.
3. (3) LEASE ACTION Type of lease action performed, New Lease, Modification or Renewal
4. (4) DEPARTMENT. Enter agency name.
5. (5) LEASE ACTION EXPLANATION. Explain the lease action.
6. (6) COMPLIANCE CRITERIA. Check appropriate selection.
 

A. (7) PRIOR APPROVAL.	Check appropriate selection.
B. (8) MODIFICATION TO STANDARD LEASE.	Check appropriate selection.
C. (9) LEASE COMPLIANCE WITH 255.25.	Check appropriate selection.
D. (10) SPACE :MEASURED.	Check appropriate selection.
E. (11) PROCUREMENT BY CODE 60-H COMPLIANCE	Check appropriate selection.
F. (12) SUSTAINABLE BUILDING RATING.	Check appropriate selection.
G. (13) ZONE FOR USAGE.	Check appropriate selection.
H. (14) ENERGY STAR BUILDING.	Check appropriate selection.

7. (15) SIGNATURE – **Staff Director of General Services Signature or Designee**
8. (16) TITLE
9. (17) DATE





**STATE OF FLORIDA**  
**Certification of Compliance**  
 Department of Management Services Form 4113

Lease Number: \_\_\_\_\_ **(1)** \_\_\_\_\_

Date: \_\_\_\_\_ **(2)** \_\_\_\_\_

Lease Action: \_\_\_\_\_ **(3)** \_\_\_\_\_

**Purpose**

This form certifies that the associated lease action complies with all applicable statutes and rules.

**1. Leasing Agency**

\_\_\_\_\_ **(4)** \_\_\_\_\_

**2. Lease Action Explanation**

\_\_\_\_\_ **(5)** \_\_\_\_\_

**3. Compliance Criteria**

**(6)**

The undersigned hereby certifies that this lease, lease number \_\_\_\_\_ **(1)** \_\_\_\_\_, is in the Best Interests of the State and in compliance with all applicable leasing criteria, in that:

		Yes	No	N/A
A. Approval of Space Need was obtained.	<b>(7)</b>	<input type="checkbox"/>	<input type="checkbox"/>	<input type="checkbox"/>
B. Modifications to the standard lease document were submitted, with a comprehensive analysis, as required in subsection 60H-1.003, Florida Administrative Code.	<b>(8)</b>	<input type="checkbox"/>	<input type="checkbox"/>	<input type="checkbox"/>
C. The lease complies with subsection 255.25(8), Florida Statutes.	<b>(9)</b>	<input type="checkbox"/>	<input type="checkbox"/>	<input type="checkbox"/>
<i>Two or more leases were not acquired in the same facility or complex, without a competitive solicitation within the previous twelve months based on the commencement date of the leases.</i>				
D. Space was measured or otherwise verified, and the Net Usable Square Footage shown is in accordance with subsection 60H-2.003, Florida Administrative Code.	<b>(10)</b>	<input type="checkbox"/>	<input type="checkbox"/>	<input type="checkbox"/>
E. Procurement was conducted pursuant to subsection 60H-1.015, Florida Administrative Code (leases 5,000 square feet or more) or subsection 60H-1.016, Florida Administrative Code (leases less than 5,000 square feet).	<b>(11)</b>	<input type="checkbox"/>	<input type="checkbox"/>	<input type="checkbox"/>
F. A Sustainable Building Rating and Energy Performance Analysis (EPA) or a Florida Energy Modeling Program (FEMP) was performed.	<b>(12)</b>	<input type="checkbox"/>	<input type="checkbox"/>	<input type="checkbox"/>
G. The subject premises are zoned to allow proposed usage.	<b>(13)</b>	<input type="checkbox"/>	<input type="checkbox"/>	<input type="checkbox"/>
H. An Energy Star rated building, where viable or cost-effective, was selected.	<b>(14)</b>	<input type="checkbox"/>	<input type="checkbox"/>	<input type="checkbox"/>

\_\_\_\_\_ **(15)** \_\_\_\_\_  
 Signature

\_\_\_\_\_ **(16)** \_\_\_\_\_  
 Title

\_\_\_\_\_ **(17)** \_\_\_\_\_  
 Date

Page: 1 of 1  
 Form: 4113 Rev.  
 Date: 9/13

Form incorporated by reference, subsection 60H-1.021(2)(c), Florida Administrative Code.



**State of Florida  
Department of Children and Families**

XXXXXXXXXX  
Governor

XXXXXXXXXX  
Secretary

**MEMORANDUM**

**DATE:**

**TO:** \_\_\_\_\_, Assistant Secretary for Administration

**FROM:** \_\_\_\_\_, Regional General Services Manager

**SUBJECT:** Prior Approval of Lease Number 590:XXXX

**ROUTING:**

**General Services:** \_\_\_\_\_, Leasing Coordinator

**ASG General Services:** \_\_\_\_\_, Staff Director of General Services

**HQ Financial Management:** \_\_\_\_\_ **(if cost increase)**  
**Budget** \_\_\_\_\_, Budget Manager

**Program Director:** \_\_\_\_\_, Program Director

**HQ General Counsel:** \_\_\_\_\_, General Counsel

**APPROVAL:** \_\_\_\_\_, Assistant Secretary for Administration

**PURPOSE:**

**BACKGROUND:**

**ACTION REQUESTED:**

*Mission: Work in Partnership with Local Communities to Protect the Vulnerable, Promote Strong and Economically Self-Sufficient Families, and Advance Personal and Family Recovery and Resiliency*

## Chapter 10.

### FREE LEASE – SUBLEASE

#### NOMINAL – NO – CONSIDERATION LEASES

At times, community partners entities or individuals would like to have our services offered at their sites. In these situations, the individual or entity would give us a portion of space to occupy to perform these services at no cost or nominal cost. For Any location that the department has personnel or equipment, we must have a lease in place. These leases do not require DMS approval. We send the documents to DMS for filing purposes.

- Nominal or no consideration leases are not governed by Chapter 255
- Leases for nominal (not to exceed (\$1.00/year) or no consideration (free) are encouraged. Such leases may include, as separate charges, arrangement to pay actual or pro-rated cost of utilities, janitorial services, and special assessment. The requirements of Section 60H-1.024, Florida Administrative Code, are not applicable for nominal or no consideration leases.
- No prior approval from the Department of Management Services is required.
- Prior approval from the State Fire Marshal is needed, even if renovations are not required.
- An executed DCF Lease Agreement to reflect the intent of the parties or the Lessor Agreement however the lease document must be approved by the Legal Counsel before execution.
- Form 4108 must be used for filing with DMS.

**PROCESS**

1. Program notifies the General Services Manager of a acquired a Nominal No Consideration office space.
2. Contact the Lessor and requests the following information:
  - Address of space
  - Square footage and description of the space to be occupied.
  - Square footage of entire facility
  - Lessor's address
  - Lessor's FEID# or SSN# (if individual)
  - Name of individual signing the lease and their title
3. Request from DMS a Nominal/No Consideration Lease number.
4. Prepare the following documents:
  - DCF Free Lease Agreement
    - If using the Lessor Agreement, ask the Lessor for scanned a copy of his agreement for Legal review and approval.
      - Notify the Lessor for any changes made by Legal for concurrence.
  - FM 4108 Nominal or No Consideration Lease Agreement
5. Send a scanned copy of the approved document to the Lessor and request to sign.
7. Once the Lessor returns the signed agreements, forward to the Staff Director of General Services for signature:
  - Free Lease Agreement
  - Nominal/No Consideration Lease Form 4108.
10. Once documents are signed by the Staff Director of General Services, route the following to DMS:
  - Agreement
  - Nominal/No Consideration Lease Form
  - Transmittal Letter
11. Once DMS sends approval letter, distribute documents as follows:
 

Lessor	Free Lease Agreement DMS Approval Letter
File	Free Lease Agreement Nominal No Consideration Lease Form Fire insurance coverage form DMS Approval Letter
14. Lease action is completed.



## State of Florida Department of Children and Families

### FREE LEASE AGREEMENT

**Lease #** \_\_\_\_\_

**THIS LEASE AGREEMENT** is entered into this \_\_\_\_\_ day of \_\_\_\_\_, 20\_\_\_\_ by and between those Parties listed below.

**Lessee: Department of Children and Families** \_\_\_\_\_ **Region**

**Address:** \_\_\_\_\_  
Street City State Zip Code

**Lessor:** \_\_\_\_\_  
Lessor Name

**Address:** \_\_\_\_\_  
Street City State Zip Code

**A. Description of Premises**

A. In consideration for the covenants and agreements made here, Lessor agrees to lease to Lessee those Premises (hereinafter the "Premises") described as:

**Building:** \_\_\_\_\_ **County:** \_\_\_\_\_  
Building Name

**Address:** \_\_\_\_\_  
Street City State Zip Code

consisting of an aggregate area of \_\_\_\_\_ square feet of net rentable space measured in accordance with the Department of Management Services' Standard Method of Space Measurement. This space comprises approximately \_\_\_\_\_% of the \_\_\_\_\_ net square feet in the building.

B. Lessor also is providing \_\_\_\_\_ parking spaces as part of this Free Lease Agreement.

**2. Term**

The term of the Lease shall commence \_\_\_\_\_ and continue month to month until cancelled by either party.

Or

The term of this lease shall be \_\_\_\_Months commencing at 12:01 a.m. local time on the 1 day of \_\_\_\_\_, 20\_\_\_\_ and terminating at 12:00 a.m. on the \_\_\_\_\_ day of \_\_\_\_\_, 20\_\_\_\_.

Lease #:

**3. RENT**

The Lessee hereby agrees to pay to the Lessor the sum of \$ -0- per month for the rental period described in Article Two.

**CO-LOCATED COSTS**

Since there is no monthly rental payment for the space that the Lessee will occupy in the facility, the Lessee agrees to pay to the Lessor monthly the amount of \$ \_\_\_\_\_, their proportionate share of the operating expenses.

Or

Since there is no monthly rental payment for the space that the Lessee will occupy in the facility, the Lessee agrees to pay to the Lessor monthly, their proportionate share of the operating expenses as outlined on Addendum \_\_\_\_\_ Operating Expenses (or percent of co-located services) per month as its share of the co-located costs for the rental period described in Article Two. The items listed on Addendum A of this agreement shall be billed proportionately monthly based on the actual cost of the service, the rates listed on the addendum are representative of a "Not-to-Exceed" cost projection.

The operating expense payment shall be payable the month following occupancy in accordance with Section 25.422, Florida Statutes. The payment shall be paid to the Lessor at:

\_\_\_\_\_  
Street Address City State Zip Code

**4. BASE LEASE**

The Lessor represents that it has a lease which includes the leased premises, Lease No.: \_\_\_\_\_ ( \_\_\_\_\_ ), a copy of which is attached to this sublease and is incorporated herein by reference as if fully set out here, in and further, that it has the legal right to sublease the described sublease interest.

**5. UTILITIES**

The Lessor (Lessee or Lessor) shall be exclusively responsible for all utilities, deposits, and charges for the leased property including charges of water, sewage, and trash pick-up.

**6. INSURANCE AND LIABILITY FOR INJURY**

Each party shall insure its own interest to the extent that it may appear to prudent to do so. The Lessor and Lessor shall not be liable for any injuries to the Lessee, his agents, employees, clients, customers, guests, or invitees, sustained upon the said leased property, except for any negligence of the Lessor.

**7. RENEWAL OPTION**

Any renewal of this lease shall be subject to the Lessor's ability to keep the base lease in effect for the remainder of its term or through the contemplated extension or renewal. The Lessee is hereby granted the option to renew this lease for \_\_\_\_\_ - \_\_\_\_\_ -year additional year(s) upon the same terms and conditions as specified in this agreement. If the Lessee desires to renew this lease under the provisions of this Article, it shall give the Lessor written notice thereof not less than three months prior to the expiration of the term provided in Article Two of this lease or any applicable renewal period.

**8. INJURY OR DAMAGE TO PROPERTY ON PREMISES**

All property of any kind that may be on the premises during the term of this lease shall be at the sole risk of the Lessee, and except for any gross negligence of the Lessor, the Lessor shall not be liable to the Lessee for loss or damage to the property.

**9. MAINTENANCE AND REPAIRS**

It is agreed that the Lessor (AKA Owner) of the premises shall be responsible for the maintenance and upkeep of the outside of the building and major repairs to the leased premises including electrical, plumbing, and air conditioning within the building, and in the event the premises hereby leased becomes untenable by reason of fire, windstorm or other events beyond the control of the Lessee or the Lessor, that during such period the rental provided for herein shall cease, and the Owner shall have a reasonable time during which to make the required repairs, or in the event the Owner elects not to rebuild or repair said premises, then this lease shall cease and terminate. The Owner shall be responsible for any regular maintenance and minor repairs to the property. The Lessee shall not alter the structure without the written consent of the Lessor.

**10. ASSIGNMENT AND SUBLETTING**

The Lessee shall make no unlawful, improper, or offensive use of the premises; nor assign or sublet any part of said premises without the written consent of the Lessor. Lessee shall quit and deliver up said premises at the end of said term in as good condition as they are now, except for ordinary wear and tear.

**11. USE OF PREMISES**

The Lessee will not make or suffer any unlawful, improper or offensive use of the premises or any use or occupancy thereof contrary to the laws of the State of Florida or to such Ordinances of the City and/or County in which the demised premises are located, now or hereinafter made, as may be applicable to the Lessee. The Lessee further agrees to adhere to the building management policies that are set forth by the Lessor for all tenants, visitors and occupants of the facility.

**12. EXPIRATION OF TERM**

At the expiration of the term, the Lessee shall restore the premises to as good a state of repair as they were prior to the commencement of the lease.

**13. RIGHT TO TERMINATE**

Lessor and Lessee hereby agree that either party may terminate this agreement by giving the other party 30-days written notice of such action, termination shall be effective 30-days after receipt of notice delivery.

**14. NOT CONSENT TO SUE**

The provisions, terms or conditions of this Lease shall not be construed as a consent of the State of Florida to be sued because of said leasehold interest.

**15. DEFINITION OF TERMS**

- (a) The terms "lease," "lease agreement," or "agreement" shall be inclusive of each other and shall also include any renewals, extensions or modifications of this lease.
- (b) The terms "Lessor", "Lessee", and "Owner" shall include their successors and assigns for the parties hereto.
- (c) The singular shall include the plural and the plural shall include the singular whenever the context requires or permits.





# FORM 4108

STATE OF FLORIDA



## DEPARTMENT OF MANAGEMENT SERVICES LEASES FOR NOMINAL OR NO CONSIDERATION

Lease No.:

TO: Department of Management  
Services Bureau of Leasing

FROM: Department of:   
Division of:   
Bureau of:

1. Type Space:  Office  Warehouse  Domiciliary

2. Agency or individual and address with whom occupancy agreement has been consummated:

Lessor's Federal Identification Number  
(F.E.I.D. or S.S.)

3. Location: Building Name   
Street   
City

4. Square footage  (Measured in accordance with the Department  
of Management Services' Standard Method of Space Measurement)

Lease No. \_\_\_\_\_

5. Term of Agreement \_\_\_\_\_

6. Options, if any \_\_\_\_\_

7. Remuneration:

_____	Free (no cost)	
_____	Nominal Rate per square foot / annual rate (Any amount less than \$1.00/year)	\$ _____
_____	Charges for Services Only (Electricity, water, copier, data) / estimated annual cost	\$ _____

8. Number of FTE housed at this location: \_\_\_\_\_

9. Brief description of function occupying space:

\_\_\_\_\_

10. The undersigned hereby certifies that this space is being used for a valid State function and that provisions for security of leased space have been accomplished. A legal agreement, copy attached, has been consummated for its use, and that the agreement and all support documents comply with established leasing criteria including Standards for Special Facilities for Physically Disabled and Fire Safety Standards of the State Fire Marshal.

11. Attach a copy of the formal agreement.

Signed: \_\_\_\_\_  
Agency Head

Date: \_\_\_\_\_

Title: \_\_\_\_\_

## SUBLEASING

There are several types of subleasing situations which may be encountered. The agency may be a sublessor as long the provider is under contract with the department or sublessee in a state-owned or privately-owned facility. The procedures in each case are unique and are treated separately in this chapter.

### A. AS SUBLESSEE IN A PRIVATELY-OWNED OR DMS FACILITY.

1. In addition to the documents normally submitted subleases require:
  - The lease agreement between the Owner and the provider sublessor to the department.
  - Written consent from Owner to Lessee to enter into a sublease with the department.
  - Signed Disclosure Statement by the Owner of the facility not the sublessor.
2. For the department to sublease a private sector facility, the same procedures are to be followed as those in normal lease acquisitions procedures. The only difference the department is leasing from the Lessee rather than facility owner.
3. The Standard Lease Agreement will be used without modifications to the lease.

### B. AS SUBLESSOR IN A PRIVATELY-OWNED OR DMS FACILITY.

- The department can sublease to a community partner as long they are under contract.
  - If not under contract the department doesn't have the budget authority to collect rent.
  - If under contract the lease cost will be reduced from their contract.
- A written consent from the Lessor is needed to enter into a sublease with another agency or community partner.
- If it's a DMS facility:
  - The request must contain specific reasons why it is in the best interest of the state to have the entity situated in the state building.
    - A statement of the entity's activities to meet the "public purpose".
- The sublease is to include:
  - Reference to the primary lease between the Agency and the DMS.
  - Clauses as necessary to delineate:
    - The exact area to be used.
    - Liabilities and insurance required of the entity.
    - Cost allocation of expenses (utilities, janitorial, etc.), if applicable.
    - Term of the agreement and other clauses as needed to define responsibilities of the parties.
- Generally, rent should be charged at a rate which will compensate the Agency for the expenses incurred by the basic lease, and other expenses.
- The Department Sublease Agreement must be used; modifications to the sublease agreement must be approved by the Legal Counsel.

## PROCESS TO SUBLEASE IN A PRIVATE SECTOR

1. Program notifies General Services wanting to collocate with a community partner in their facility.
  - At the community partner facility:
    - Refer to Chapters 4 or 5 depending to the square feet.
      - Prepare a SAW and DRSN
      - Send to Central Office for review and approval.
      - If the proposed space is over 2,000 sq./ft. select Tenant Broker (If required)
  - After DMS approval:
    - Lease over 5,000 sq./ft., Refer to Chapter 5, the community partner is required to bid.
    - Lease under 4,999 sq./ft., Refer to Chapter 4, obtain a minimum of 3 quotes.

## PROCESS TO SUBLEASE IN A PRIVATE SECTOR LEASE AS SUBLESSOR

1. Program notifies General Services wanting to collocate with a community partner in our facility.
  - The community partner must have a contract with the department in order to subtract the lease cost from the contract, otherwise the department doesn't have a way to collect the rent.
  - Verify that the community partner is not for profit.
    - If for profit, the community partner needs to register with the Department of Revenue to pay for the lease taxes.
    - A written consent from the private sector Lessor is needed to enter-into a sublease with another agency or community partner.
    - In a DMS facility:
      - A request to DMS and approval is needed;
      - The request must contain specific reasons why it is in the best interest of the department to have community partner situated in the DMS facility.
      - A statement of the entity's activities so as to meet the "public purpose".
      - The proposed area being used by the community partner.
  - Upon receiving and approval from the Lessor or DMS prepare the Agency Sublease Agreement.
    - The lease term should be from July to June.
    - Forward 2 copies to Sublessor for original signature.
      - Upon receipt from Lessor, review all pages have been initialed and signed by Sublessor and no changes have been made to the agreement.
      - Send to the Region Legal Counsel and Staff Director of General Services for review and signature.
      - Forward to DMS an executed agreement for record filing.
      - Send an executed copy to the Sublessor.
    - Send to Central Office scanned copy of sublease documents.
  - The sublease process is completed.



State of Florida  
Department of Children and Families

**SUBLEASE AGREEMENT**

**Region:**  
**Lease Number:**

This Sublease Agreement, entered into this \_\_\_\_\_ day of \_\_\_\_\_ A.D. between the State of Florida, Department of Children and Families, hereinafter called Sublessor or the Department, and

\_\_\_\_\_  
hereinafter called Sublessee.

The Sublessor and the Sublessee, for and in consideration of the mutual promises made herein and for other good and valuable consideration recited below, hereby agree as follows:

**1. DESCRIPTION OF SUBLEASED PREMISES**

Sublessor will sublease, and the Sublessee will rent, upon the terms and conditions set out in this agreement, the following described property:

\_\_\_\_\_  
Name of Building

\_\_\_\_\_  
Street Address                                  City                                  County                                  Zip Code

Consisting of an aggregated area of \_\_\_\_\_ square feet of rentable space in accordance with the Department of Management Services' Standard Method of Space Measurement which comprises approximately \_\_\_\_% net square feet in the building at the rate of \$\_\_\_\_\_per square foot per year. The Sublessor shall also provide \_\_\_ parking spaces for the non-exclusive use of the Sublessee as part of this agreement.

**2. TERM**

The term of this Sublease shall be \_\_\_\_\_ Months commencing at 12:01 a.m. local time on the \_\_\_ day of \_\_\_\_\_, 20\_\_\_ and terminating at 12:00 a.m. on the \_\_\_ day of \_\_\_\_\_, 20\_\_\_

**3. RENT**

The Sublessee hereby agrees to pay to the Sublessor the sum of \$\_\_\_\_\_per month for the rental period described in Article Two for a total payment over the full term of this sublease of \$ \_\_\_\_\_. Each rental payment shall be payable the month following occupancy in accordance with Section 215.422, Florida Statutes. The rent shall be paid to the Sublessor at:

\_\_\_\_\_

Street Address	City	State	Zip Code

**4. CO-LOCATED COSTS**

In addition to the monthly rental payment described in Article Three, the Sublessee agrees to pay to the Sublessor monthly, the sum of \$ \_\_\_\_\_ (or percent of co-located services) per month as its share of the co-located costs for the rental period described in Article Two.

All other costs such as Telephone, mail service (i.e. postage meter, Fedex, UPS, etc.),office supplies, copier and fax will be billed directly to the Sublessee according to the normal business practices of the Sublessor. None of these costs will be the responsibility of any of the programs of the Department of Children and Families.

**5. BASE LEASE**

The Sublessor represents that it has a lease which includes the subleased premises, Lease No.: \_\_\_\_\_ , a copy of which is attached to this sublease and is incorporated herein by reference as if fully set out here, in and further, that it has the legal right to sublease the described sublease interest.

**6. UTILITIES**

The \_\_\_\_\_ (Sublessee or Sublessor) shall be exclusively responsible for all utilities, deposits, and charges for the subleased property except for any charges of water, sewage, and trash pick-up, which shall be paid by the Owner.

**7. INSURANCE AND LIABILITY FOR INJURY**

Each party shall insure its own interest to the extent that it may appear to prudent to do so. The Lessor and Sublessor shall not be liable for any injuries to the Sublessee, his agents, employees, clients, customers, guests, or invitees, sustained upon the said leased property, except for any negligence of the Lessor.

**8. RENEWAL OPTION**

Any renewal of this sublease shall be subject to the Sublessor's ability to keep the base lease in effect for the remainder of its term or through the contemplated extension or renewal. The Sublessee is hereby granted the option to renew this lease for \_\_\_\_\_ additional month(s) upon the same terms and conditions as specified in this agreement. If the Sublessee desires to renew this lease under the provisions of this Article, it shall give the Sublessor written notice thereof not less than three months prior to the expiration of the term provided in Article Two of this lease or any applicable renewal period.

**9. INJURY OR DAMAGE TO PROPERTY ON PREMISES**

All property of any kind that may be on the premises during the term of this lease shall be at the sole risk of the Sublessee, and except for any gross negligence of the Sublessor, the Sublessor shall not be liable to the Sublessee for loss or damage to the property.

**10. MAINTENANCE AND REPAIRS**

It is agreed between Sublessor and Sublessee that only the Owner of the subleased premises shall be responsible for the maintenance and upkeep of the outside of the building and major repairs to the subleased premises including electrical, plumbing, and air conditioning within the building, and in the event the premises hereby leased becomes untenable by reason of fire, windstorm or other events beyond the control of the Sublessee or the Sublessor, that during such period the rental provided for herein shall cease, and the Owner shall have a reasonable time during which to make the required repairs, or in the event the Owner elects not to rebuild or repair said premises, then this lease shall cease and terminate. The Owner shall be responsible for any regular maintenance and minor repairs to the property. The Sublessee shall not alter the structure without the written consent of the Sublessor.

**11. ASSIGNMENT AND SUBLETTING**

The Sublessee shall make no unlawful, improper, or offensive use of the premises; nor assign or sublet any part of said premises without the written consent of the Sublessor. Sublessee shall quit and deliver up said premises at the end of said term in as good condition as they are now, except for ordinary wear and tear.

**12. USE OF PREMISES**

The Sublessee will not make or suffer any unlawful, improper or offensive use of the premises or any use or occupancy thereof contrary to the laws of the State of Florida or to such Ordinances of the City and/or County in which the demised premises are located, now or hereinafter made, as may be applicable to the Sublessee.

**13. EXPIRATION OF TERM**

At the expiration of the term, the Sublessee shall restore the premises to as good a state of repair as they were prior to the commencement of the lease.

**14. RIGHT TO TERMINATE**

In the event that Sublessor's lease agreement with the owner (Lease Number 590: ) is terminated pursuant to the terms of that agreement, this sublease agreement shall terminate on the same date. The Sublessor and Sublessee hereby covenant and agree that if default shall be made in the payment of the aforesaid rent for a period of thirty (30) days, or if the Sublessee shall violate any of the covenants of this agreement then the Sublessee shall become a tenant at the sufferance or a tenant at will of the Sublessor, thereby waiving all rights of notice, and the Sublessor shall be entitled to immediately re-enter and retake possession of the demised premises. Any waiver of the Sublessor under this clause for any period of time shall not prevent its subsequent election to enforce the same during the continuance of said violation.

**15. NOT CONSENT TO SUE**

The provisions, terms or conditions of this Lease shall not be construed as a consent of the State of Florida to be sued because of said leasehold interest.

**16. DEFINITION OF TERMS**

- (a) The terms "lease," "lease agreement," or "agreement" shall be inclusive of each other and shall also include any renewals, extensions or modifications of this lease.
- (b) The terms "Sublessor", "Sublessee", and "Owner" shall include their successors and assigns for the parties hereto.
- (c) The singular shall include the plural and the plural shall include the singular whenever the context requires or permits ;

**17. FULL TERM AND CONDITIONS**

This document contains the full and complete agreement by and between the Sublessor and Sublessee, any changes, modifications, corrections, deletions or extension shall be made in writing and signed by both parties.

Witnesses as to:  _____  _____	SUBLESSOR  Florida Department of Children and Families  By: _____ <div style="text-align: center; font-size: small;">Staff Director of General Services</div>
Witnesses as to:  _____  _____	SUBLESSEE  By: _____



## Chapter 11

## Tenant-at-will and change of ownership

## TENANT-AT-WILL

Tenant-At-Will is used when the agency remains in an existing space after the lease has expired. The rate may be the same as long the Lessor agrees otherwise the Lessor can demand double rent, when the lease expired and notice of termination of tenancy shall be determined by the periods at which the rent is payable. A Tenant-At-Will should only be used when all other leasing options have been exhausted.

(For statutory information, See F.S. 83.01, F.S. 83.02, F.S.83.03 and F.S. 83.06)

Timeline: The process should begin the first working day of every month.

## PROCESS

1. Request permission from the Lessor to become a Tenant At Will and a specific period. (Time can be adjusted depending on the situation).
2. Prepare the following and get the authorized signature Staff Director of General Services:
  - Invoice
  - Request for Payment at Tenant At Will form
3. Once the authorized signature authority has signed the request for payment, scan and email submit the following to DMS:
4. Upon receipt of approved documents from DMS, route the documents as follows:
 

Fiscal	Approved Request for Payment Form and Invoice
File	Approved Request for Payment Form
5. When the space is to be vacated, we must notify in advance the Lessor of termination of the TAW, by email - 30 days' notice prior to termination date.
6. Lease action is complete.

REQUEST FOR TENANT AT WILL PAYMENT  
FM 4112

INSTRUCTIONS

1. LEASE NUMBER: Enter the lease number.
2. LOCATION: Enter City and County office space located.
3. AGENCY: Department of Children and Families
4. DIVISION: Enter Program(s) occupying space.
5. REASON: Enter the reason of Why? the need of the TAW status.
6. LEASE EXPIRED: Date that original lease expired.
7. LESSOR: Enter the name of the Lessor the payment is for.
8. MONTHLY RENTAL RATE: Enter the current monthly rental rate.
9. TIME PERIOD: Enter the dates for which the payment is for.
10. PAYMENT AMOUNT: Enter the payment amount that is being requested.
11. CALCULATION: Enter the annual lease amount divided by 12
12. REPLACEMENT LEASE NUMBER: Enter the lease number that will replace this TAW office space.
13. STATUS: Enter the status of the replacement lease.
14. ESTIMATED DATE: Enter the date that the replacement space will be ready.
15. SIGNATURE AUTHORITY: Staff Director of General Services or designee sign the request before sending to DMS.
16. APPROVAL: DMS will sign form if approved.



STATE OF FLORIDA  
DEPARTMENT OF MANAGEMENT SERVICES  
REQUEST FOR PAYMENT OF RENTAL AS A TENANT-AT-WILL  
AND AUTHORIZATION

Lease Number **(1)** \_\_\_\_\_ Location: **(2)** \_\_\_\_\_

Agency: \_\_\_\_\_ **(3)** \_\_\_\_\_

Division: \_\_\_\_\_ **(4)** \_\_\_\_\_

Reason for Tenant-at-will status: \_\_\_\_\_ **(5)** \_\_\_\_\_

This Lease Expired: \_\_\_\_\_ **(6)** \_\_\_\_\_

Lessor: \_\_\_\_\_ **(7)** \_\_\_\_\_

Monthly Rental Rate: \_\_\_\_\_ **(8)** \_\_\_\_\_

Time Period For Which Payment Is Requested: \_\_\_\_\_ **(9)** \_\_\_\_\_

Payment Amount Requested: \_\_\_\_\_ **(10)** \_\_\_\_\_ Calculation \_\_\_\_\_ **(11)** \_\_\_\_\_

Replacement Lease Number(s): \_\_\_\_\_ **(12)** \_\_\_\_\_ & \_\_\_\_\_

Status of Replacement Lease: \_\_\_\_\_ **(13)** \_\_\_\_\_

Estimated Date of Occupancy of Replacement Space: \_\_\_\_\_ **(14)** \_\_\_\_\_

REQUESTED: _____ <b>(15)</b> _____  (x) _____  _____  TITLE  DATE: _____	APPROVED: _____ <b>(16)</b> _____  (x) _____ DIV. OF REAL ESTATE DEVELOPMENT AND MANAGEMENT  _____  TITLE  DATE: _____
--	---

**ATTACHMENTS: INVOICE VOUCHER**

### CHANGE OF OWNERSHIP

When ownership of a facility changes, the records of the agency, DMS and the comptroller must be changed. Lessors do not always notify the user agency of ownership changes. As soon as you gain knowledge of an ownership change, contact the new owners and request the required documentation.

NOTE: We cannot change the payee names without DMS prior approval.

#### PROCESS

1. The Facilities Services Manager’s office receives notification from Lessor that there has been a change of ownership.
2. Notify ASG to request in TRIRIGA a change of ownership and request from new Lessor the following:
  - Notification letter from former Lessor of selling the facility.
  - Notification letter from new Lessor with the FEID#, contact information and where to send payment.
  - Copy of the Warrantee Deed.
  - Executed Disclosure Statements
  - Executed Public Entity Addenda
  - Division of Corporation New Owner Information FEID#
  - Ask new Lessor to register in MFMP.
  - W-9
3. Upon receipt of requested documents from Lessor, route all documents to ASG.
4. Once receive the DMS Approval Letter, distribute the documents as follows:
 

Fiscal	DMS Approval Letter
File	DMS approval letter
	Warranty Deed
	Disclosure Statement
	Executed Public Entity Addendum
	Notification letter from former Lessor.
	New Lessor letter.
	Division of Corporation New Owner Information
	W-9
6. The lease action is completed.

# Agency Review Checklist

## Change of Ownership <sup>(1)</sup>

TRIRIGA ID:

LEASE NUMBER:

LOCATION:

EFFECTIVE DATE:

AGENCY:

AGENCY LEASE LIAISON:

DMS LEASE SPECIALIST:

NEW OWNER:

PREVIOUS

**REQUEST FOR SPACE NEEDED (RSN) APPROVAL**  
[TRIRIGA](#)

**Documents Required from Agency for DMS review:**

Submit RSN in TRIRIGA *(Please complete all fields)*

Employment Eligibility Verification(E-Verify Form) FM-4054K

Recorded Warranty Deed

Division of Corporations New Owner Information-FEID

Fully Executed Disclosure Statement FM-4114

Formal Letter from New Owner to Agency

Comments

---

---

---

---

---

<sup>(1)</sup> Applicable per Rule 60H-1.0261

### CHANGE OF PAYEE

Lessors sometimes assign the management of their property to a property management firm, financial institution or to other individuals. Depending on the lessor, they may want all or part of the property managed by this entity. If the Lessor chooses to have rental payments sent to this entity, then this process must be followed.

NOTE: We cannot change the payee names or addresses without DMS prior approval.

### PROCESS

1. The Facilities Services Manager's Office receives notification from Lessor changing payee information. This notification must be:
  - Signed by the Lessor
  - On Lessor's letterhead (If applicable)
  - Have name and address of new payee.
2. Send the requested information to DMS and Central Office.
3. Notify the Lessor to make the changes in his account at MFMP
4. Upon receipt of approval from DMS, distribute the documents as follows:

Fiscal	DMS Approval Letter
File	DMS Approval Letter Letter from Lessor
5. Lease action is completed.



## 12. DMS STANDARD METHOD OF SPACE MEASUREMENT

This general overview of the DMS standard for measuring office space allows a reader to get a general idea on how office space should be measured for state rental purposes. The DMS standard has been the generally accepted method for measuring office space for many years. It should be noted that this standard must be used in measuring office space in old as well as new buildings. It is applicable to any architectural design or type of construction.

### ***What is the Difference between Usable vs. Rentable Square Feet?***

Knowing the difference between usable square feet and rentable square feet can mean all the difference in evaluating the best deal on a commercial lease. Office space is generally listed with a rentable square footage rate, which includes more square feet than the actual space the tenant will occupy. So how can the Lessee know what it is paying for, and get great space for the best price?

### ***Usable Square Feet***

Usable square feet include the specific area the tenant will occupy in order to do business. For a partial-floor lease, this includes all office space plus any storage. There are no exclusions for columns, recessed entries, or the like; either-column space is fair game in the calculation of total usable square feet. When a tenant occupies a full floor, the usable square feet amount extends to everything inside the boundaries of the building floor, minus bathrooms, stairwells, elevator shafts, janitorial closets, mechanical and electrical rooms.

### ***Rentable Square Feet***

A commercial office building is not made up of private offices and cubicles alone. Corridors, meeting spaces, lobbies, stairways, restrooms and so on are used by all building tenants, and landlords charge for the use of this space as well. Rentable office space means the usable square feet of the office space plus a pro-rata share of building common areas. Pro-rata means that tenants pay for these common areas in proportion to the amount of space they lease in the building.

Establishing and understanding of the standard for measuring usable space is a foundation needed when negotiating state leases. Under the DMS Standard Method of Space Measurement, user agencies shall pay rent as Lessees of state owned or privately-owned buildings only for usable space as defined below:

- Usable space is floor space that has usable value. It does not include outer building walls but includes space covered by interior walls.
- If an interior wall separates spaces occupied by two tenants, half of the wall is included in each tenant's measurement.

- Usable space does not include bathrooms, stairs, exit stair passageways, public corridors, main entrance lobbies, elevator lobbies, elevator shafts, flues, furnaces, pipe shafts, vertical ducts, air conditioning rooms, fan rooms, janitor closets, electrical closets, and such other equipment and building support rooms not actually available to the tenant for furnishings and personnel and their enclosing walls.
- Usable space includes columns and projections necessary to the building. Any other corridors are usable, chargeable space and, if shared by other agencies, shall be prorated.

## PREPARING FLOOR PLANS AND SQUARE FOOTAGE CALCULATIONS

1. Floor plans verifying the net rentable square footage are to be submitted with new leases or modifications to increase or decrease square footage on leases 5,000 square feet or greater. This requirement may be met by using either a scaled line drawing or an architect's blueprint. The plans must contain all dimensions and calculations following the standard method of space measurement, necessary to compute the net rentable square footage. They should be signed by the person who physically measured the leased premises. See next page for a sample scaled line drawing floor plan.
2. Floor plans should be prepared, and square footage calculations completed before lease documents are completed. The square footage on the floor plans and the lease document must agree.
3. Drawings are to be clear with measurement lines showing to which surface of the wall the measurement applies. Many times, an architect's drawing will not indicate measurements to surfaces as required in the standard method of space method measurements procedure. In such cases, measurement lines and distances may be drawn on the floor plans to make them correct.
4. Square footage calculations must be clear and easy to follow. For clarity, areas of the facility may be designated with an alpha letter which is referenced to the calculations. Areas may be color coded if desired to make them easier to understand.
5. Any subsequent lease actions which changes the square footage must be accompanied by a new set of plans indicating the total new square footage.



Sample Scaled Line Drawing Floor Plan

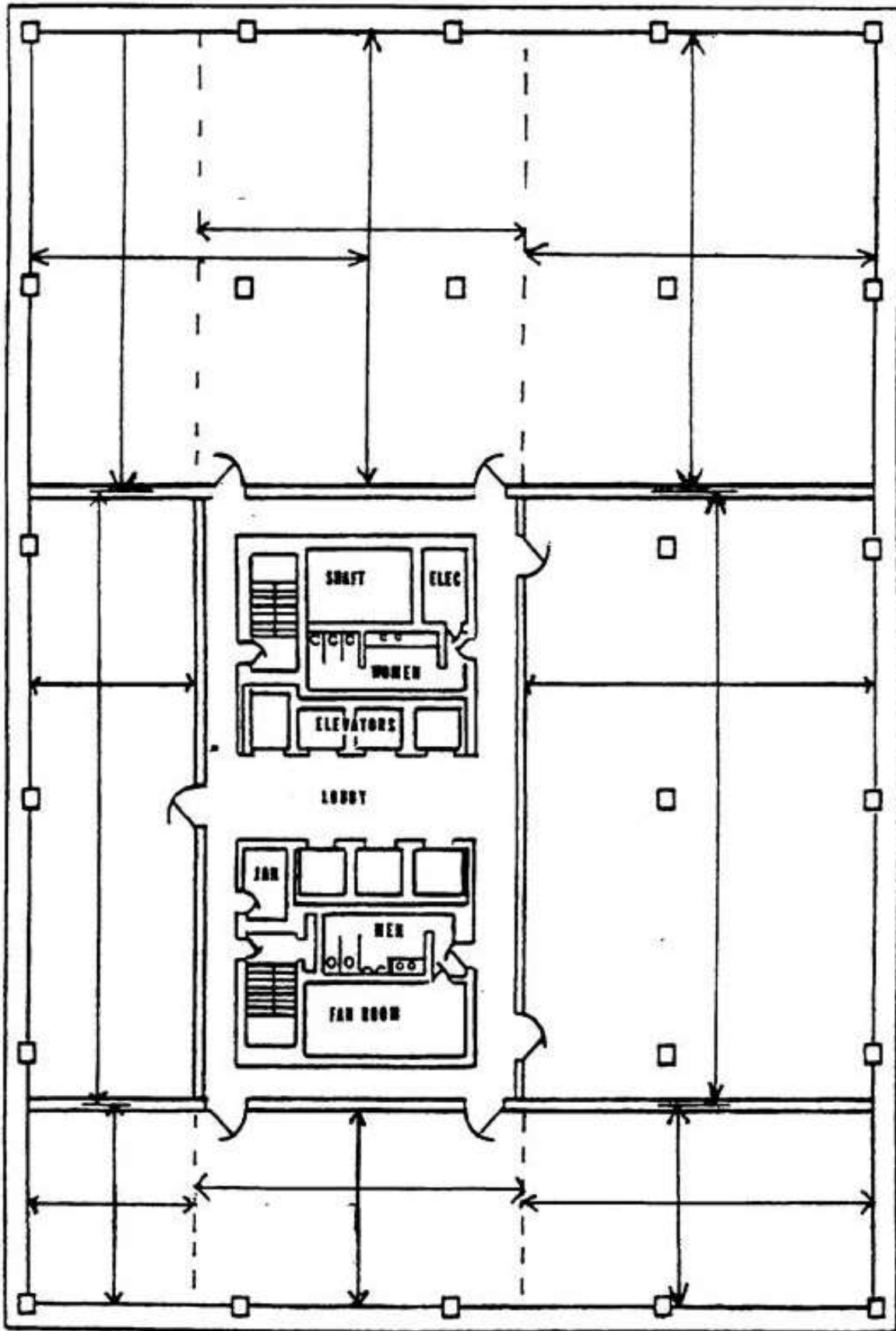



## 13. PROTEST

Any person substantially affected by any agency decision or intended decision at any point in the solicitation process may seek an administrative determination of the validity of the rule on the grounds that the rule is an invalid exercise of delegated legislative authority. The protest can be exercised if the guidelines stated in Sections 120.53(5) and 120.57(3), Florida Statutes are followed.

- Protests at the Department of Children and Families are governed by Section 120.53(5), Florida Statutes, titled Adoption of Rules of Procedure and Public Inspection. Facility services managers should consult their legal counsel for the resolution of protests.
- Any person may dispute any part of the competitive process through the filing of protest.
- A protest of award must be filed in accordance with Section 120.53(5), Florida Statutes. Failure to file a protest within the prescribed time limits shall constitute a waiver of proceedings under Chapter 120, Florida Statutes.
- A written notice of intent to protest must be filed with the contact person listed on the Request for Proposal within 72 hours from the posting of the award notice (Excluding Saturdays, Sundays and legal holidays), per Section 120.57(3), Florida Statutes.
- Within ten calendar days after the notice of intent to protest is filed, the formal written protest must be filed with the project contact person.
- The protester then has 10 days to file his formal protest. If the formal protest has not been filed within this time period the request for proceedings are waived and shall not be considered (Section 120.53, Florida Statutes).
- At the time of filing of the formal protest, a bond payable to the department in an amount equal to one percent of the total lease payments over the term of the lease or \$5,000, whichever is greater, must accompany the formal protest.
  - This bond shall be conditioned upon the payment of all costs, which may be adjudged against the protester in the administrative hearing in which the action is brought and in any subsequent appellate court proceeding. If the department prevails, it should recover all costs and charges, which shall be included in the final order or judgment, excluding attorney's fees. Upon payment of such costs and charges by the protester, the bond shall be returned. If the protester prevails, he shall recover from the agency all costs and charges which shall be included in the final order of judgment, excluding attorney's fees.

- Upon receipt of the formal written notice of protest, the leasing process shall be stopped until the protest is resolved.
- A copy of all formal protests will be forwarded to Headquarters General Services and the Department of Management Services.
- The facilities services manager has seven (7) days, excluding Saturdays, Sundays and legal holidays, to resolve the protest through mutual agreement with Region/Headquarters general counsel assistance.
- If the protest cannot be resolved by mutual agreement, Region/Headquarters general counsel pursues further actions. Depending upon the nature of the protest, a formal or informal hearing will be convened to resolve the issue.
- The protester must submit a petition in writing and present facts enough to show invalidity of rule. The petition shall be filed with the Department of Management Services, division of administration hearings (DOAH) which shall copy the Department of Children and Families immediately.
  - DOAH has 10 days after receipt to determine compliance with the filing procedures and to assign a hearing officer. A hearing must be conducted within 30 days thereafter, unless the petition is withdrawn.
  - A decision with reasons must be rendered within 30 days after the hearing.
  - A copy of the decision is forwarded to the Department of State and the appropriate legislative committee by the DOAH.
  - The Department of Children and Families must give notice in the Florida Administrative Weekly of the rule decision in first issue after avoidance.
- The Department of Children and Families must request a hearing officer from the Department of Management Services, division of administrative hearings within 10 days of petition receipt.
  - The hearing officer will review findings of facts based upon the evidence of record. The hearing officer shall submit a Recommended Order consisting of findings of fact, conclusions of law, interpretation of administrative rules and recommended penalty. Each party shall have 10 days to submit exceptions.
- The agency (Children and Families) may reject or modify the conclusions of law and rule interpretation but may not reject findings of fact in the Final Order.
- If the protester disagrees with the final order, then he/she can appeal to the 1st District Court.

- If there is an appeal, the court may award reasonable attorney's fees and cost to the prevailing party if the court finds the appeal frivolous, unwritten, an abuse of the appellate process, or a gross abuse of agency discretion.

## FLORIDA STATUTES

### **120.57 Additional procedures for particular cases.**

(3) ADDITIONAL PROCEDURES APPLICABLE TO PROTESTS TO CONTRACT OR AWARD. Agencies subject to this chapter shall utilize the uniform rules of procedure, which provide procedures for the resolution of protests arising from the contract process. Such rules shall at least provide that:

(a) The agency shall provide notice of its decision or intended decision concerning a solicitation or a contract award as follows:

1. For a solicitation, notice of a decision or intended decision shall be given by United States mail or by hand delivery.
2. For any decision of the 1Division of Purchasing of the Department of Management Services concerning a request by an agency for approval of an exceptional purchase under part I of chapter 287 and the rules of the 1Division of Purchasing, notice of a decision or intended decision shall be given by posting such notice in the office of the 1Division of Purchasing.
3. For any other agency decision, notice of a decision or intended decision shall be given either by posting the tabulation at the location where were opened or by certified United States mail or other express delivery service, return receipt requested.

The notice required by this paragraph shall contain the following statement: "Failure to file a protest within the time prescribed in s. 120.57(3), Florida Statutes, shall constitute a waiver of proceedings under chapter 120, Florida Statutes."

**(b) Any person who is adversely affected by the agency decision or intended decision shall file with the agency a notice of protest in writing within 72 hours after the posting of the RFP tabulation or after receipt of the notice of the agency decision or intended decision and shall file a formal written protest within 10 days after filing the notice of protest. With respect to a protest of the specifications contained in an invitation to negotiate or in a request for proposals, the notice of protest shall be filed in writing within 72 hours after the receipt of notice of the project plans and specifications or intended project plans and specifications in a request for proposals, and the formal written protest shall be filed within 10 days after the date the notice of protest is filed. Failure to file a notice of protest or failure to file a formal written protest shall constitute a waiver of proceedings under this chapter. The formal written protest shall state with particularity the facts and law upon which the protest is based. Saturdays, Sundays, and legal holidays shall be excluded in the computation of the 72-hour time periods provided by this paragraph.**

(c) Upon receipt of the formal written protest which has been timely filed, the agency shall stop the solicitation process or the contract award process until the subject of the protest is resolved by final agency action, unless the agency head sets forth in writing particular facts and circumstances which require the continuance of the solicitation process or the contract award process without delay in order to avoid an immediate and serious danger to the public health, safety, or welfare.

(d)1. The agency shall provide an opportunity to resolve the protest by mutual agreement between the parties within 7 days, excluding Saturdays, Sundays, and legal holidays, after receipt of a formal written protest.

2. If the subject of a protest is not resolved by mutual agreement within 7 days, excluding Saturdays, Sundays, and legal holidays, after receipt of the formal written protest, and if there is no disputed issue of material fact, an informal proceeding shall be conducted pursuant to subsection (2) and applicable agency rules before a person whose qualifications have been prescribed by rules of the agency.

3. If the subject of a protest is not resolved by mutual agreement within 7 days, excluding Saturdays, Sundays, and legal holidays, after receipt of the formal written protest, and if there is a disputed issue of material fact, the agency shall refer the protest to the division for proceedings under subsection (1).

(e) Upon receipt of a formal written protest referred pursuant to this subsection, the director of the division shall expedite the hearing and assign an administrative law judge who shall commence a hearing within 30 days after the receipt of the formal written protest by the division and enter a recommended order within 30 days after the hearing or within 30 days after receipt of the hearing transcript by the administrative law judge, whichever is later. Each party shall be allowed 10 days in which to submit written exceptions to the recommended order. A final order shall be entered by the agency within 30 days of the entry of a recommended order. The provisions of this paragraph may be waived upon stipulation by all parties.

(f) In a competitive-procurement protest, no submissions made after the RFP opening amending or supplementing the RFP shall be considered. Unless otherwise provided by statute, the burden of proof shall rest with the party protesting the proposed agency action. In a competitive-procurement protest, other than a rejection of all RFPs, the administrative law judge shall conduct a de novo proceeding to determine whether the agency's proposed action is contrary to the agency's governing statutes, the agency's rules or policies, or the RFP or proposal specifications. The standard of proof for such proceedings shall be whether the proposed agency action was clearly erroneous, contrary to competition, arbitrary, or capricious. In any RFP-protest proceeding contesting an intended agency action to reject all RFPs, the standard of review by an administrative law judge shall be whether the agency's intended action is illegal, arbitrary, dishonest, or fraudulent.

(4) INFORMAL DISPOSITION. Unless precluded by law, informal disposition may be made of any proceeding by stipulation, agreed settlement, or consent order.

(5) APPLICABILITY. This section does not apply to agency investigations preliminary to agency action.

## Chapter 14

### glossary of terms

ASG - office of general services, administrative services (Department of Children and Families).

ASGGS - facilities services office within the office of general services, administrative services (DEPARTMENT OF CHILDREN AND FAMILIES), specifically the unit which handles leasing.

ACKNOWLEDGMENT - a formal declaration before a duly authorized person such as a notary public, to the effect that the person executing the instrument is performing his free act and deed and that the signature is genuine.

ADA- (Americans with Disabilities Act) - laws prohibiting discrimination against persons with disabilities.

ADDENDUM - a supplement or addition to a lease.

AFFIDAVIT - a written declaration made under oath before an official, as a notary public.

ALLOCATION - the term used to describe how a program division/commission charges leased square footage to their respective organizational codes.

AMENITY - a feature that increases the attractiveness or value of a piece of property.

APPURTENANCE - a right, privilege, or property considered incidental to the principal property for purposes such as passage of title, conveyance, or inheritance. Anything attached to the land and thus a part of the property, such as a barn, garage, or an easement.

ASSIGNMENT - an instrument by which a lessee transfers his interest to a third party. For all practical purposes, an assignment is synonymous with a sublease.

BID - consists of the package of documents by which the department seeks to lease real property to meet its needs. This consists of a group of documents provided to each interested party.

BOUNDARIES - the precise geographic area defined by lines, streets, or roads denoting the area for the acceptable location of a site/facility. To be considered within the specified given boundaries, the site/facility must be within or abutting the defined lines of demarcation.

BROOM CLEAN- premises delivered free of debris and floors swept clean.

BTU's (British Thermal Units) - energy consumed per square foot, per year. Used in ascertaining the energy efficiency of a facility.

BUSINESS DAY- working days occurring Monday through Friday, except legal holidays observed by the State of Florida. The terms "working days" and "business days" may be used interchangeably.

C.C. and R's - covenants, conditions and restrictions of record concerning a particular property. Includes items such as setbacks, easements, and property-oriented restrictions. Usually uncovered in investigation of public records (Title Report).

**CANCELLATION** - term used when the agency wishes to discontinue a lease, RFP or other agency leasing action.

**CIRCULATION AREA** - that portion of the gross area --whether or not enclosed by partitions--which is required for physical access to some subdivision of space.

**CLEAN ROOM** - a room constructed to maintain a controlled atmosphere (humidity, temperature, dust, germ free, etc.).

**CLEAR SPAN** - area within building unobstructed by columns or posts.

**CERTIFICATE OF COMPLIANCE** - form used to demonstrate adherence to the rules and procedures set forth by DMS.

**CERTIFIED MINORITY BUSINESS ENTERPRISE (CMBE)** - a business which has been certified by the Minority Business Advocacy and Assistance Office.

**CERTIFICATE OF OCCUPANCY** - the certificate issued by the appropriate official from the jurisdiction or jurisdictions where the offered property of facility is located, which signifies that the building or structure has met all construction requirements of such jurisdiction, and that the structure or facility may be occupied by persons.

**COMMENCEMENT DATE** - date in which an action is be in force.

**COMPARATIVE MARKET ANALYSIS (CMA)** - an analysis of the subject's property value, which is not necessarily a valid indication or estimate of its market value.

**CONCRETE TILT-UP** - method of construction whereby concrete walls of a structure are poured in forms on surface of floor, allowed to set, then elevated to position by means of a crane.

**CORPORATION** - an artificial being or person, invisible, intangible created by law as a representative of those who contribute to or become holders of shares in the property entrusted to it for a common purpose. Florida Corporations and foreign corporations must be registered with the Florida Department of State.

**COVENANTS** - clauses in the lease or underlying deed which define or limit the rights and obligations of lessor or lessee.

**COMMON AREA** - any area of a building whose use is shared by other tenants. Examples include primary lobby, restrooms, primary (entrance) corridors, etc.

**CRITICAL PATH** - form used to keep track of the status of lease actions on pending leases.

**CUSTODIAL AREA** - the sum of all areas on all floors of a building used for building protection, care, maintenance, and operation.

**DMS** - the Department of Management Services, specifically the Bureau of Property Management, Division of Facilities Services.

**DAY** - one calendar day.

**DAY OF OCCUPANCY** - the date following the issuance of any applicable certificate of occupancy when a building or facility has been inspected and is accepted by the department.

**DEED** - a legal document conveying title to real estate.

**DEED OF TRUST** - a legal document conveying the title of real estate to a trustee who holds the title as security until the owner of the property has repaid a debt. Also called a *Trust Deed* or *Trust Indenture*.

**DEMOGRAPHICS** - a collation of data representing the clients served within a determined area.

**DEPARTMENT** - the division of Florida State Government which is issuing this Request for Proposal (RFP), or its successor in interest. The complete name of the department which issued this RFP is provided on the first page of this RFP. As used in this document, the word "department" refers to the full formal name of the issuer of this RFP.

**DISCOUNT RATE** - an interest rate provided to us by DMS in order to calculate the value of future money into today's value. Primarily used to compare the values of rental payments over time.

**DISTRICT** - the fifteen geographic subdivisions of the department.

**DOCK HIGH** - refers to the design of a building which provides loading through doors at truck level. Normal height would be between 42 and 52 inches.

**DRY AND MEASURABLE** - these are essential characteristics to describe "existing" proposed space. To be considered as "dry and measurable", the proposed space must be enclosed with finished roof and exterior walls in place. Interior floors need not be completed. Exterior windows and doors need not be installed. The proposed area is not required to be completed.

**ENERGY PERFORMANCE INDEX** - a number describing the energy limits of a facility per square foot of floor area per year stated in BTU consumption per square foot per year.

**ENTERED INTO DATE** - date in which the department signs the lease documents.

**ESCALATION CLAUSE** - a clause in an agreement providing for an adjustment, usually increase, of a price rent, interest rate or to accelerate the time frames for payment of moneys due.

**EVALUATION** - term used to describe the process in determining whether a proposed space is the lowest and in the best interest of the state.

**EXCULPATORY CLAUSE** - provision in loan agreement relieving borrower of responsibility for deficiency judgments, often occurring automatically when unpaid balance reaches value of land securing the loan.

**EXISTING FACILITY** - to be considered existing, the proposed space must be enclosed with a roof system and exterior walls in place.

**EXTENSION** - an agreement to extend the ending date of the lease term.

**EXCLUSIVE PARKING SPACES** - parking designated and identified by the lessor for the sole and exclusive use of the lessee 24 hours per day, 7 days per week, without interference from or



concurrent use by others. By offering parking spaces, the lessor agrees to take whatever steps are necessary to assure that the department enjoys exclusive use of those spaces as described here unless agreed otherwise in writing.

**FAIR RENTAL VALUE** - the price that a ready and willing tenant would pay, as of the Rent Adjustment Date, as annual rent to a ready and willing landlord of premises comparable to the premises if such premises were exposed for lease on the open market for a reasonable period of time.

**FEMP** - Florida Energy Modeling Program.

**FLORIDA ENERGY MODELING PROGRAM (FEMP)** - a computerized program for evaluating a building's energy use, utilizing the normal systems designs and evaluation block load programs.

**FISCAL** - term used in relating to financial matters.

**FOOTCANDLE** - the illumination of a surface one-foot distance from a source of one candle, equal to one lumen per square foot. For purposes of this RFP, foot-candles will be measured using a General Electric Type 214 Light Meter or its equal to be supplied by the lessor.

**FREE SPACE** - term used to describe space in which the lessor does not charge the agency for use.

**GROSS AREA** - the sum of the floor areas included within the outside faces of exterior walls for all stories, or areas, which have floor surfaces.

**GROSS LEASE** - the antonym of net lease. One in which the lessor pays taxes, insurance, maintenance, operating expense, etc.

**HOTELING** - equipped office space available on a reservation basis for use by multiple employees, who are not in the office daily basis.

**INTERSTITIAL SPACE** - that portion of the gross area which cannot be put to use because of the presence of structural or service features of the building.

**JOINT VENTURE** - a special combination of two or more persons, wherein some specific venture for profit is jointly sought without any actual partnership or a corporate designation.

**LEASE** - the contract entered into by a department and the successful preparer of an RFP/Quote, which shall incorporate, among other provisions, the contents of the RFP/Quote and the successful proposer's response to the RFP/Quote, except as specifically provided to the contrary in the lease document, and which gives the department a current possessor interest in the building or facility. The terms "lease" and "contract" may be used interchangeably.

**LESSEE** - a person who acquires the right to possession and use of a premises under a lease.

**LESSOR** - a person who transfers the right to possession and use of a premises under a lease.

LETTER OF AGENCY STAFFING - form used to determine the amount of space needed for a new lease or when there is a change of staffing or square footage in any existing lease.

LIEN - a legal hold or claim which a person or entity has upon the property of another as security for some debt or charge.

LIFE-CYCLE COST ANALYSIS - a life-cycle cost analysis is a means of computing a standardized economic value of each property being examined, including consideration of future operating and repair costs, as well as initial cash outlays. The basic procedure for life-cycle cost analysis (LCC) was established by the American Society for Testing and Materials (ASTM). This technique is an industry standard for measuring the total costs that can be expected from long-lived facilities and their major components. A life-cycle cost analysis makes it possible to objectively compare the cost of different properties that are being considered for the same purpose and to identify the least costly alternative available to decision-makers at the present time. The output of LCC analysis is a uniform measure of the present economic value of costs that will extend over a long period into the future.

LIMITED PARTNERSHIP - a partnership (which like a corporation is created pursuant to statute and must be registered with the Florida Department of State). It is a legal entity like a corporation, but it has general and limited partners instead of stockholders. Limited partners have the same limited liability for the debts of the limited partnership as do stockholders in a corporation. The general partners have the same unlimited liability as do partners in general (non-limited) partnerships. In a limited partnership only, the general partners may participate in its management affairs.

LOWEST AND BEST PROPOSAL - that proposal selected by the department following an objective and detailed process to evaluate and compare proposals. "Lowest" refers to the lowest present value cost of a proposal based on the rental rate criteria. "Lowest and Best" refers to the evaluation score. Weights for evaluation criteria are described in each RFP.

MECHANICAL AREA - a portion of a building designed to house mechanical or electrical equipment.

MINIMUM RENT - a NNN "net net, net rental", as those terms are used and understood in the real property leasing business. Accordingly as additional rent tenant pays all taxes and assessments levied against the premises, or any portion thereof, public utility and related costs and expenses, insurance premiums for insurance hereof, expenses of occupying, operating, altering, maintaining and repairing the entire premises, and any other expenses or charges which during the Lease Term shall be levied, assessed or imposed by any governmental authority upon or with respect to, or incurred in connection with, the possession, occupation, operation, alteration, maintenance, repair and use of the Premises, it being intended that this lease shall result in a rent to be paid to Landlord, without additional cost to Landlord or diminution or offset thereto, in the fixed monthly amount specified.

MODIFICATIONS - changes to the standard lease agreement that change the terms of original lease.

NET ASSIGNABLE AREA - the sum of all areas on all floors of a building assigned to, or available for assignment to, an occupant, including every type of space functionally usable by an occupant.

NET LEASE - a lease in which the tenant pays all or a substantial part of the cost of operating and maintenance. There are various expressions used in the real estate business to describe the many variations in net lease transactions. For instance, if a lease provides for the tenant to pay all operating expenses, maintenance costs, insurance real estate taxes, etc., it might be referred to as "100% net" or "net-net". If the lease provides for the tenant to maintain and operate the premises only, it might be referred to as "net-excepting for taxes, insurance and outside repairs".

NET RENTAL - rental paid under a net lease agreement.

NOMINAL/NO CONSIDERATION (FREE) LEASE - a lease in which the agency occupies space at a cost of \$1.00 per year or at no cost.

ORDER - a final agency decision reduced to writing and filed with the person in charge.

ORGANIZATIONAL CODE - accounting term used to describe a specific organizational unit or area.

PARTNERSHIP - ownership by a voluntary association (by written or oral contract) between two or more persons whereby they place their money, effects, labor, and skill, or some or all of them, in the commence of business.

PHYSICAL DETERIORATION - depreciation of property due to wear and tear and the action of the elements.

PRE-RFP CONFERENCE - a meeting held prior to the Bid, RFP, ITN opening for potential proposers to have questions answered in relation to the RFP.

PREMISES - property, which is leased, i.e., a building or any part thereof.

PRESENT VALUE - term used to describe the value of future dollars today.

PRIMARY AND SECONDARY RENTAL - A lease covenant under which a rental is divided into two categories. The primary rental is a fixed amount usually based upon a definite percentage of property value and established at the time of the execution of the lease agreement. The secondary rental, which would be pro-rated according to the space which a tenant might occupy in a building, covers the expense of taxes, repairs and insurance, water, heat, etc. The secondary rental agreement achieves the same result as an escalation clause.

PRIME TENANT - When one or more subleases have been made on a property, the original lessee is sometimes referred to as the prime tenant.

PRIVATELY OWNED - Any privately or publicly owned building not owned by the State of Florida.

PROPOSED ORDER - The advance text of the order a collegial agency plans to enter as their final order.

PROGRAM LIAISON - the designated program/office representative that works with the facilities services manager office on various leasing issues that affect their respective division/office.

PROTEST - term used to describe an individual's disagreement with the agency's decision or intended decision.

PROPOSAL - all materials submitted by a prospective proposer in response to this RFP.

**PUBLIC ENTITY CRIME** - as defined in paragraph 287.133(1)(g), Florida Statutes, means a violation of any state or federal law by a person with respect to and directly related to the transaction of business with any public entity or with an agency or political subdivision of any other state or with the United States, including but not limited to, any proposal or contract for goods or services, any lease for real property, or any contract for the construction or repair of a public building or public work, involving antitrust, fraud, theft, bribery, collusion, racketeering, conspiracy, or material misrepresentation.

**PROSPECTIVE PROPOSER** - any firm or person who submits a proposal to the department in response to this RFP.

**PROTECTIVE COVENANTS** - (Restrictive Covenants). A contract to protect and preserve the character and integrity of the area covered by covenant (use, size, kind, set-backs, architectural, etc.). Applied individually as sold or recorded and applied simultaneously to all property in a development.

**PURCHASE ORDER REQUISITION** - form used to request purchases. Primarily, we use this form to request to purchase newspaper advertisements.

**QUOTE** - term used to describe a new lease less than 5,000 square feet.

**RADON GAS** - a naturally occurring radioactive gas that, when it has accumulated in a building in sufficient quantities, may present a health risk to persons exposed to it over a period of time.

**RECEIVER** - a person or entity appointed by the court to manage a property being foreclosed.

**RECOMMENDED ORDER** - the official recommendation of a hearing officer of the Division of Administrative Hearings (DOAH).

**REED ACT** - federal act directed to the Department of Labor in which provided funding for the building of or procurement of real estate.

**RENEWAL OPTION** - a lease covenant giving the lessee the right to extend the lease for an additional period of time on specified terms.

**RENTAL RATE** - The cost of space measured in terms of dollars per square foot per year or as otherwise defined by the Lease Agreement or Addendums. No rental rate shall contain an escalation clause that contains an open rate, be tied to the Consumer Price Index, or have an open rental escalation clause. (60H-1.006 Escalation Clause)

**REQUEST FOR SPACE NEED (RSN)** - form used when certifying space need.

**REQUEST FOR PROPOSAL** - the RFP consists of the package of documents by which the department seeks to lease real property to meets its needs. This consists of a group of documents provided to each interested party.

**RESPONSIVE PROPOSAL** - a proposal which conforms in all material respects to this RFP.

**RULE** - each agency statement of general applicability that implements, interprets, or prescribes law or policy or describes the organization, procedures or practice requirements of an agency.

February

16,

2024

CFOP 70 - 1 SANDWICH LEASE - intermediary instrument in three or more leases on the same property, i.e., A leases to B, B leases to C, C subleases to D; the agreement between B and C would be called a "sandwich lease".

SECURITY - assume of money, or equivalent, deposited by the lessee with the lessor or a trustee, as guarantee for performance under the lease terms.

STANDARD LEASE AGREEMENT - lease Form Number 4054 on which leases for real property are written.

STATE - the State of Florida and its departments, boards and commissions, officers, and employees.

STATE OWNED - any building owned by the State of Florida or any agency.

STATE OWNED DEPARTMENT OF MANAGEMENT SERVICES MANAGED - any building owned by the State of Florida under the management and leasing authority of the Department of Management Services. These facilities are referred to as facilities pool buildings.

SUBCONTRACTOR - any person other than an employee of the proposer who performs any of the services listed in this RFP for compensation.

SPECIAL ASSESSMENT - a charge levied against a property by the government to finance improvements which benefit the property, such as street pavement or a sewer line.

SUBLESSOR - SUBLESSEE - SUBLEASE - sometimes a tenant is permitted to lease his interest to a third party. The original lessee thereby becomes a sublessor. The new tenant is the sublessee. The new agreement between sublessor and sublessee is a sublease.

SUBORDINATION - a lender permitting a debt due him to be subordinated or inferior to the debt of another lender on the same property.

SUBORDINATION CLAUSE - clause in mortgage or trust deed providing that it may be secondary to mortgage or trust deed to be recorded later. Also, can exist in lease designating either lender or tenant as having rights secondary to the other in event of foreclosure on landlord's loan obligation.

SUBROGATION - the substitution of one party for another in a claim, lien or cause of action against others.

SYNOPSIS - form used to consolidate all the information received from a proposer to send to DMS.

TENANT AT WILL - term used for the agency's position when it has to remain in an existing space after a lease has expired usually due to difficulties in getting a new lease finalized; the option is always up to the lessor to allow us to remain in the space; the agency remains in space as a tenant-at-will at the same rates on a month to month basis.

TENANT AT SUFFERANCE - term use for the agency's position when it has to remain in an existing space after a lease has expired without the permission of the lessor.

TENANT BROKER - Each contracted tenant broker shall work under the direction, supervision, and authority of the state agency, subject to the rules governing lease procurements.

TENANT IMPROVEMENTS (TI) - Work performed to the interior of a leased space, paid for by the lessor, to accommodate the specific needs of the tenant.

TERM - the specified duration of the lease.

TERM - LEASE TERM - the specified duration of the lease, i.e., "the lease has a term of 10 years". When used in the plural, this word has a different meaning; it is then usually synonymous with "covenants", i.e., "the terms of the lease provide that the tenant must maintain the property in good condition and make all interior repairs".

TRUCK WELL - a ramp and/or level area below ground level which creates loading at truck height.

TERMINATION - term used when the agency discontinues a lease, RFP or other agency leasing action.

TRANSMITTAL - form used to route documents to DMS.

TRUST - the legal relationship between one person having equitable partnership (beneficial ownership) in the property and another person, the trustee, who holds legal title to the property (for the use or benefit of the other).

UPS - Uninterruptable Power Supply.

VENDOR INFORMATION PORTAL (VSIP) – A Department of Management Services (DMS) Portal System that provides access to all bid solicitations, including invitations to Bid (ITB), Requests for Proposals (RFP), Invitations to Negotiate (ITN), etc. Registered vendors can request email notifications as well as view current bid advertisements online.



## 15. OFFICE SPACE STANDARDS AND GUIDELINES

### INTRODUCTION

These new and revised “DCF Office Space Standards and Guidelines” will be used when planning and designing office space.

The space allocation standards guidelines for office design recognize the programs’ needs to stay current with trends and best practices in space management and provide functional work environments for employees.

### PRINCIPLES

The standards and guidelines incorporate the following key principles:

**Programs are empowered to plan their office space.** This principle recognizes that, if office space is treated as an administrative resource and managers are given the opportunity to plan office space using simplified standards and guidelines, more creative, cost-effective solutions to satisfying office space needs will result.

**Standards and guidelines should be simplified.** This principle recognizes that simplified, minimum standards and broad guidelines written in non-technical language will enable departments to plan their own office.

**Space should be allocated according to functional requirements.** This principle recognizes that the simply allocating office space to people based on their position or rank in an organizational hierarchy rather than the functional needs of their work may result in a less productive workplace and additional costs.

**Space should be flexible.** This principle recognizes that fewer barriers to change, less disruption when change does occur, and lower costs in money and time can be accomplished by:

- using open space planning whenever practical;
- reducing the number of different sizes of spaces; and,
- standardizing the sizes of as many spaces as possible.

## AUTHORITIES

The Regional Managing Director, Program Manager and Regional Budget must certify to the Assistant Secretary of Administration and General Services that the FTEs for which office space is requested and the special purpose space that is requested **are bona fide requirements of the program.**

Where the request can be accommodated within the existing office space inventory, General Services has the authority to proceed with the project.

Where additional funding is required for leased space, General Services will submit a request to the Lessor and negotiate for tenant improvements (TI) to the lease.

The Office of General Services shall approve the functional program and the design of tenant improvements for the office space.

## IMPLEMENTATION

The office General Services will provide project management services for the procurement, design, construction and tenant improvements in all leased or owned facilities.

A functional program must be completed for each project to verify space requirements and confirm project costs.

General Services shall provide guidance to the program on the cost-effective design of the tenant improvements.

## REPORTING

General Services will submit a report to the Program with an inventory lists of leased office space needing lease action 18-month prior expiration.

The report will list:

- the Region – Circuit – Location
- the office building
- the number of FTEs, as certified by Solaris
- the allocation of general office space, as per DCF standard
- the allocation of special purpose space
- the actual space occupied
- the budget impact by modifying vs. procurement

Program must provide to General Services:

- Detailed number of FTE's by classification (supervisors, clerical, paraprofessional, OPS)
- Number of Hoteling and staff frequency in office



- Number of Telecommuter and staff frequency in office
- Number of transition staff
- Number of OPS
- Number of people per training room and frequency of training
- Number people per conference room and frequency of meetings
- Number of clients visit per day
- Clients per hour
- Client turn over
- Demographics

## OFFICE DESIGN

### Purpose

The following guidelines will provide direction when designing office space. The guidelines serve as a reference for sound management decisions and must be followed unless there are justified reasons for deviations.

### General Guidelines

The following space planning and design guidelines are recommended:

- In order to create flexibility, promote air quality, increase natural light penetration and reduce costs, attempt to limit the number of enclosed workstations to 45% of the total workstations on a floor.
- Enclosed workstations may be provided to senior managers (e.g., director level and above) and positions which conduct continuous confidential meetings (e.g., daily for at least 4 hours during the day). The supervision of staff and/or occasional confidential meetings is not usually considered enough cause for an enclosed workstation. The provision of meeting rooms and shared Quiet Rooms is a more efficient and functional solution.
- Enclosed offices should be positioned on the building core and provided with glazing to receive natural light. Screens should be 1.65m (65") or lower in height.
- Allocate approximately 35% of the space as circulation space.
- For periodic large group (25 or more people) meetings, conference rooms should be rented from the private sector rather than accommodated in general office space. However, if private conference facilities are not available locally, departments can provide for conference-size rooms by connecting adjoining meeting rooms with ceiling height, soundproof, moveable partitions.

- Departments should consider collocating in order to share support spaces and equipment and reduce costs.
- Plan space so that short term space requirements are isolated from longer term requirements to enable future space reductions.
- To promote open workstation planning, Quiet Rooms can be provided for small group meetings and work requiring privacy. To provide maximum functionality as shared workstations, Quiet Rooms should be equipped with furniture, computer equipment and communications connections.
- To create flexibility, apply a modular approach to planning; i.e., plan spaces which are compatible with building grids.
- Plan the size of smaller support spaces so that they can be interchangeable with workstations for people.
- Attempt to standardize workstation furniture so that, when moves occur, only people need to move.

### Space Allocation Standards

Administrative Space: These standards describe the allocation of office space to DCF Programs. The standards do not establish or imply minimum space entitlement and programs are encouraged to consider ways of meeting their requirements using less space.

The administrative space will be calculated using the following allocations:

<b>Personnel Areas</b>	<b>FTE Sq./Ft.</b>
Manager and Professional Confidential	100
Professionals & Supervisor Workstation	80
Para-Professional Workstation	60
Telecommuters / "Hotelers" Workstation	36

Support Space: In addition to general administrative space, programs require standard purpose space.

<b>Standard Support Allocations</b>	<b>FTE Sq./Ft.</b>
Reception (no clients service area)	100
LAN Room	75
Open Files (9 sq./ft FTEs)	9
Storage (1-40 FTEs)	100
Pantry (1-60 FTEs)	200

Children Supply's	100
Copy Room (1-60 FTEs)	100

<b>Conference Meeting Areas</b>	<b>Sq./Ft.</b>
Conference Room (17-up Persons)	350
Conference Room (9-16 Persons)	250
Conference Room (5-8 Persons)	150
Conference Room (2-5 Persons)	100
Open Teamwork Area	100
Quiet Room	50

General Administrative Space: Justify 35% circulation space.

Special Client Support Space: Special client support space requirements must be determined through a functional program and justified based on client services to be accommodated.

<b>Special Client Support Allocations</b>	<b>FTE Sq./Ft.</b>
Client Lobby Area	5' Client
Service Counter/Computer Area	3' unit
Interview Rooms	82
Phone Booth	42
Care Coordinator Room	80
Visitation Room	100
Playroom	100
Training Rooms (up to 12 Persons)	400
Training Rooms (up to 18 Persons)	550
Training Rooms (up to 24 Persons)	660

Special Client Support Space: Justify 30% circulation space.

Clients Hour	Lobby	Clients Hour	Parking Hour
10	50	10	8
20	100	20	15
30	150	30	23
40	200	40	30
50	250	50	38
75	375	75	56
100	500	100	75
125	625	125	94
150	750	150	113
175	875	175	131
200	1,000	200	150
225	1,125	225	169
250	1,250	250	188
275	1,375	275	206
300	1,500	300	225
325	1,625	325	244
350	1,750	350	263
400	2,000	400	300
450	2,250	450	338
500	2,500	500	375
550	2,750	550	413
600	3,000	600	450

Space Estimate Example: Assuming a department requires office space for 20 FTEs, and it doesn't require a client service area, the estimated space requirement would be calculated as follows:

FTE	Sq./Ft.	Sq./Ft.
5	Manager and Professional Confidential (100 sq. ft. each)	500
5	Professionals & Supervisor Workstation (80 sq. ft. each)	400
10	Para-Professional Workstation (60 sq. ft. each)	600
	Reception, no client	100
	LAN Room	75
	Open Files	180
	Storage	100

	Pantry	200
	Copy Room	100
	Conference Room	250
	Open Teamwork Area	100
	Administrative Space:	2,605
	Circulation Space:	912
	Administrative Space Requirement:	3,517
	Sq. Ft./FTE	175

### WORK AREA ALLOCATION

The following is a list of recommended office and workstation sizes for various job functions. Using these recommended sizes will promote efficient space planning within building grids and provide flexibility for accommodating future organizational changes.

Space Type	Functional Assignment	Space Allocation
Enclosed Type A	Frequent meetings with others and/or requiring confidentiality, security, visual and acoustical privacy. Typical assignment to Manager or Supervisor.	100 sq. ft.
Workstation Type B	Concentrated in multi-source paperwork: compiling information, reading, writing, analyzing, calculating and referencing multiple sources of material; allows for manual and automated drafting functions. Typical assignment for managerial, supervisors without needs of confidentiality, professional or technical staff.	80 sq. ft.
Workstation Type C	Multi-task paper intensive work: telephone work, keyboarding, filing, sorting documents, handling mail, editing, operating equipment, scheduling, receiving visitors. Typical assignment for secretary and administrative support staff.	60 sq. ft.
Open Type D	Specific, task-oriented work, focusing on infrequent office use, data input into electronic media. Typical assignment for clerical and data-entry staff.	36 sq. ft.

## SUPPORT SPACES ALLOCATION

The following is a list of recommended space planning allowances for office support functions.

Support Space	Typical Space Allocation and Functional Assignment
Filing Cabinet	Allow 9 ft <sup>2</sup> per filing cabinet.
Plan Cabinets	Allow 15 ft <sup>2</sup> per plan storage cabinet.
Storage Shelf Units, Storage Rooms	Allow up to 10 ft <sup>2</sup> per shelving unit either free-standing or within storage rooms.
Photocopier Area	Allow 50 ft <sup>2</sup> for standard photocopying requirements to include paper storage and work surface.
General Work Area	Allow up to 50 ft <sup>2</sup> for common/shared workstation for functions such as mail sorting, computer equipment, facsimile machine, etc.
Reference Library	<ul style="list-style-type: none"> <li>• Allow up to 10 ft<sup>2</sup> per shelving unit.</li> <li>• Allow 50 ft<sup>2</sup> per reading and worktable</li> </ul>
Local Area Network (LAN) Computer Room	Space allocation determined on a case by case basis with a minimum 75 ft <sup>2</sup> .
First Aid Room	First Aid Room will be provided based on regulations under the Safety Act. For buildings with multiple departments, space for First Aid Room will be allocated based on number of FTEs in each department. Minimum 100 ft <sup>2</sup>
Reception Area	Space allocation based on functional needs; e.g., visitor/customer traffic, security requirements, reception activities, etc.
Quiet Rooms	Allow 1 Quiet Room of 50 ft <sup>2</sup> for every 10 open workstations. Hotelers or Telecommuters not included.
Meeting Rooms	<ul style="list-style-type: none"> <li>• Meetings of 2 to 5 people allow 100 ft<sup>2</sup></li> <li>• Meeting of 5 to 8 people allow 150 ft<sup>2</sup></li> <li>• Meeting of 8 to 12 people allow 250 ft<sup>2</sup></li> <li>• Meetings of 13 people and up allow 350 ft<sup>2</sup></li> </ul>
Coffee Counter/Nook	Allow 1 counter/nook of 12.5 ft <sup>2</sup> <ul style="list-style-type: none"> <li>• per 30-FTE department; or</li> <li>• per floor, where departments each have less than 30 FTEs.</li> </ul>

## OFFICE OF GENERAL SERVICES

General Services is responsible for providing leasing management services for the design and construction of tenant improvements in all leased space or agency owned buildings.

A list of regional contacts to obtain project management services is provided below.

<b>General Services Regional Contacts</b>	
<b>Region</b>	<b>Contact</b>
Central Office	General Services
Northwest Region	General Services
Northeast Region	General Services
Central Region	General Services
Suncoast Region	General Services
Southeast Region	General Services
Southern Region	General Services

## DEFINITIONS

**Bullpen Office:** Is a set up where employees work in an open floor with no offices or partitions separating them.

**Circulation Space:** Spaces, such as corridors and aisles, provided within an office to allow for access to various work areas.

**Enclosed Workstation:** A workstation with four-sided, floor-to-ceiling enclosures using drywall, demountable or removable partitions.

**Department:** Agency program requiring office space.

**Full-Time Employee (FTE):** A measure of labor utilization which approximates the number of persons employed by a department and requiring office space. Office space planning is based on the anticipated number of FTEs at the mid-point of an occupancy or a five-year period, whichever is less.

**Functional Program:** A detailed statement describing what is needed by the program to perform its activities efficiently, safely and comfortably. It includes a description about the occupant group's requirements for each workstation, support, circulation and special purpose spaces, based upon the approved space standards and guidelines. It also describes how the areas relate to each other functionally and may describe the type and size of furniture and equipment that needs to be accommodated. A functional program is used by a designer to complete a space layout.

**General Office Space:** Office space used to accommodate general administrative functions (workstation, support, and circulation space) and does not require special design and construction because of other special program delivery activities. General office space can usually be reallocated between programs with minimal changes required.

**Guidelines:** Statements designed to provide direction when planning office space. While not mandatory, guidelines should be followed unless there is good reason not to do so.

**Office Project:** A leasing and/or construction project for provision of office space for a program. Office projects may be approved as part of a general office plan or on an ad hoc basis as a result of program requests.

**Open Workstation:** A workstation with no enclosures or two to three enclosures below ceiling height using screens or panels.

**Phone Booth:** A personal space in an open lobby area for proper privacy.

**Special Purpose Space:** Additional, non-standard areas required by a program to accommodate specific activities which are unique and essential to delivery of the department's specific program. For example, visitation rooms, interview rooms, computer rooms, workshops, central mail operations rooms, public lobby areas, conference or training areas, central storage/warehousing areas, etc. Special purpose space is not included in the space envelope allocation determined under these standards.

**Standards:** A set of prescribed maximum space allocations which must be followed when planning office space. Standards do not establish or imply minimum space entitlement and consideration should be given by departments to meet their requirements using less space.

**Support Space:** Shared space containing furniture, equipment or materials used by a program. For example, photocopier rooms, file cabinets, meeting rooms, coffee counters, etc. These shared spaces are located near the people that use them on a regular basis and may be enclosed or open depending on the type of equipment and the work performed in them.



Tenant Improvements (TI): The interior of an office building, designed and constructed to meet the requirements of the department. This includes partitions, screens, finishes, signs and modifications to telephone, lighting, electrical, heating and ventilation as necessary to service the office layout. The term 'fit up' is sometimes used to describe the construction of tenant improvements.

Total Space Justify: The total amount of general-purpose office space provided to a program, as determined under the lease standards.

Useable Space: The space that is actually useable by a program. It does not include accessory areas such as bathrooms, janitor closets, electrical and telephone closets, common area corridors and elevator lobbies. Corridors within the boundaries of a programs space are included in the useable space.

Workstation Space: Spaces provided to people to accommodate their individual furniture and equipment and allow them to perform their job functions. Workstation space may be enclosed or open depending on the confidentiality, security, visual and acoustical privacy requirements of the job.

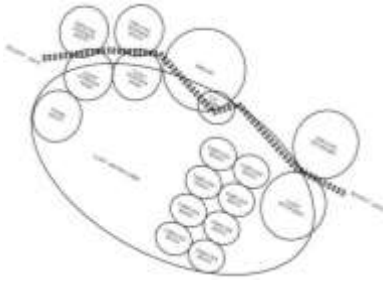

## 16. OFFICE CONSTRUCTION STANDARDS AND GUIDELINES

### PURPOSE

The Office of General Services is responsible for developing and monitoring new and renovated office installations for the Department of Children and Families; ensuring office space allocation are based on a consistent standard. The Office Space Standards and Guidelines (the Standards) have been developed to address how office environments have evolved over the past two decades.

The goal of the Standards is to optimize space and resources while providing suitable office accommodation to programs workgroups and staff. The Standards take into account the following considerations:

- functionality – meeting the needs of the employee and the program and providing workstations and shared support facilities that allow staff to work more effectively and efficiently;
- cost effectiveness – maintaining consistency in design of office spaces by using equal office elements, thereby ensuring that programs and prospect vendors can develop reliable and reasonable budgets for new and renovated tenant improvements;
- flexibility – when developing the workplace, choosing components that are adapted easily to meet changes to programs and staff;
- sustainability – adopting universal office and workstation footprints comprised of standardized components, which allows flexibility in adapting the occupancy of an installation without extensive renovation;
- consistency – basing office components (workstations and support-function areas) on one standard and applying the standard to the design of all program office installations; and,
- equitability – providing every employee and program workgroups with an equal level of workspace and support-function areas, applied throughout the department.

### WHAT IS NEW?

How can the Standards reflect recent developments in the way an office functions and the new technologies and materials available to its workers? It must address the way organizations work and how new products and technology change our office workplace. General Services must analyze the core of DCF's goals and business practices while determining whether its current office accommodation meets DCF's needs.

## ALLOCATIONS

By providing more and a greater variety of collaborative spaces, the Standards aim to meet the needs of today’s employees and to take advantage of technology that allows staff to work from many locations. The allotment includes area both for workstations and for typical office support space, including collaborative (meeting) space, equipment, layout, and storage functional components.

Personnel Areas	FTE Sq./Ft.
Manager and Professional Confidential	100
Professionals & Supervisor Workstation	80
Para-Professional Workstation	60
Telecommuters / “Hotelers” Workstation	36

## *Office Configurations*

### TYPE A: MANAGEMENT & SUPERVISORY

- ENCLOSED OFFICE TYPE 'A' 100 ft<sup>2</sup>

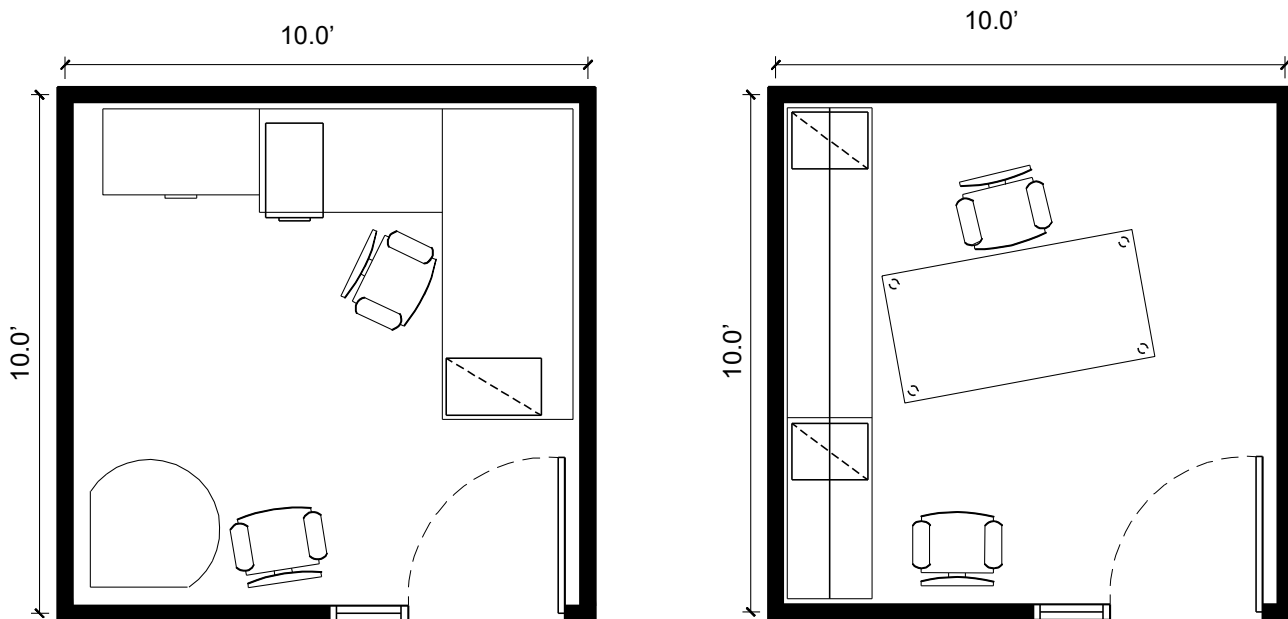

• OPEN OFFICE TYPE 'A' 100 ft<sup>2</sup>

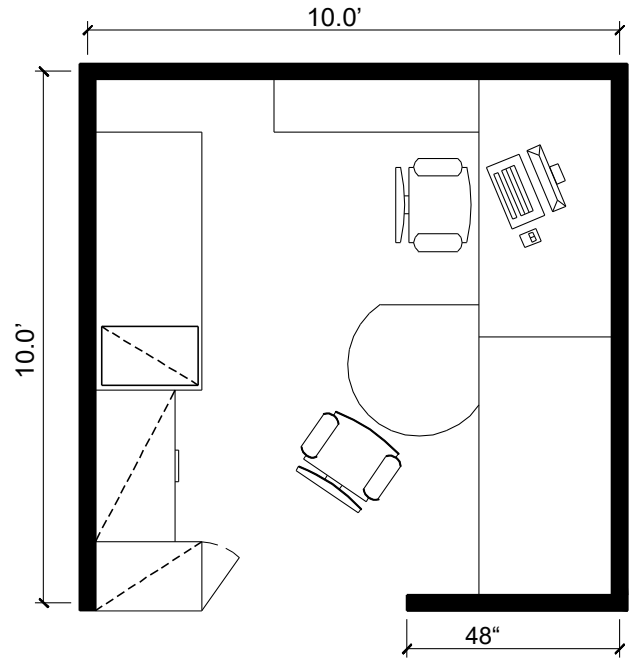
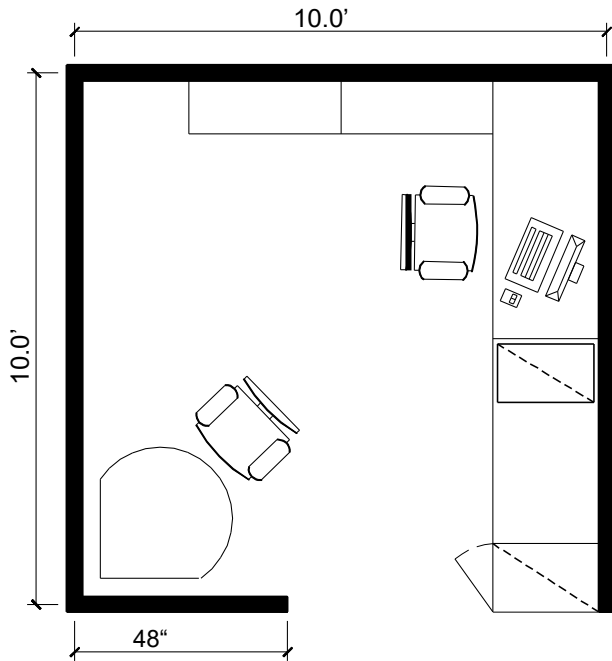

**TYPE B: PROFESSIONAL AND SUPERVISOR**  
WORKSTATION TYPE 'B' 80 ft<sup>2</sup>

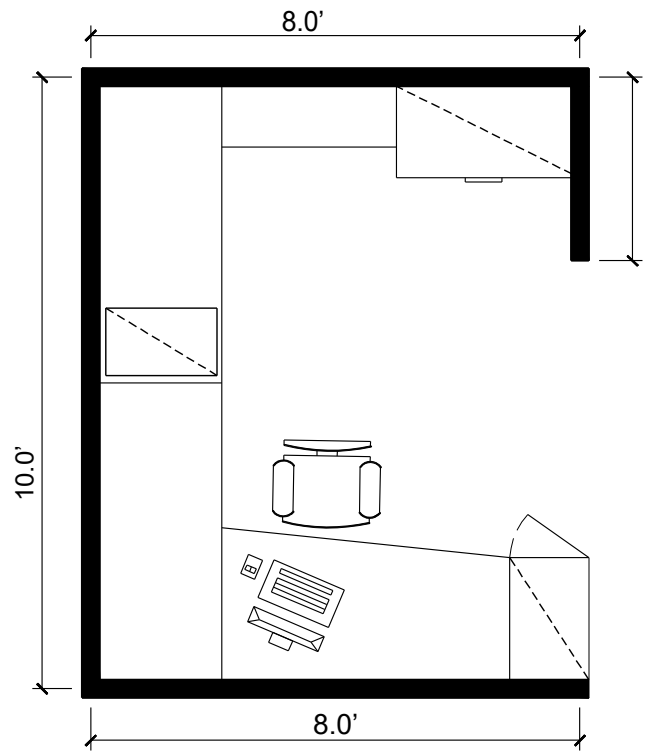
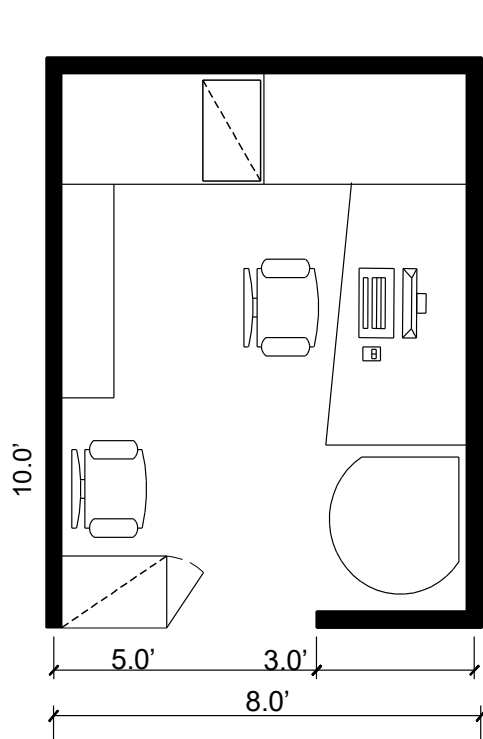

WORKSTATION TYPE 'B' 80 ft<sup>2</sup>

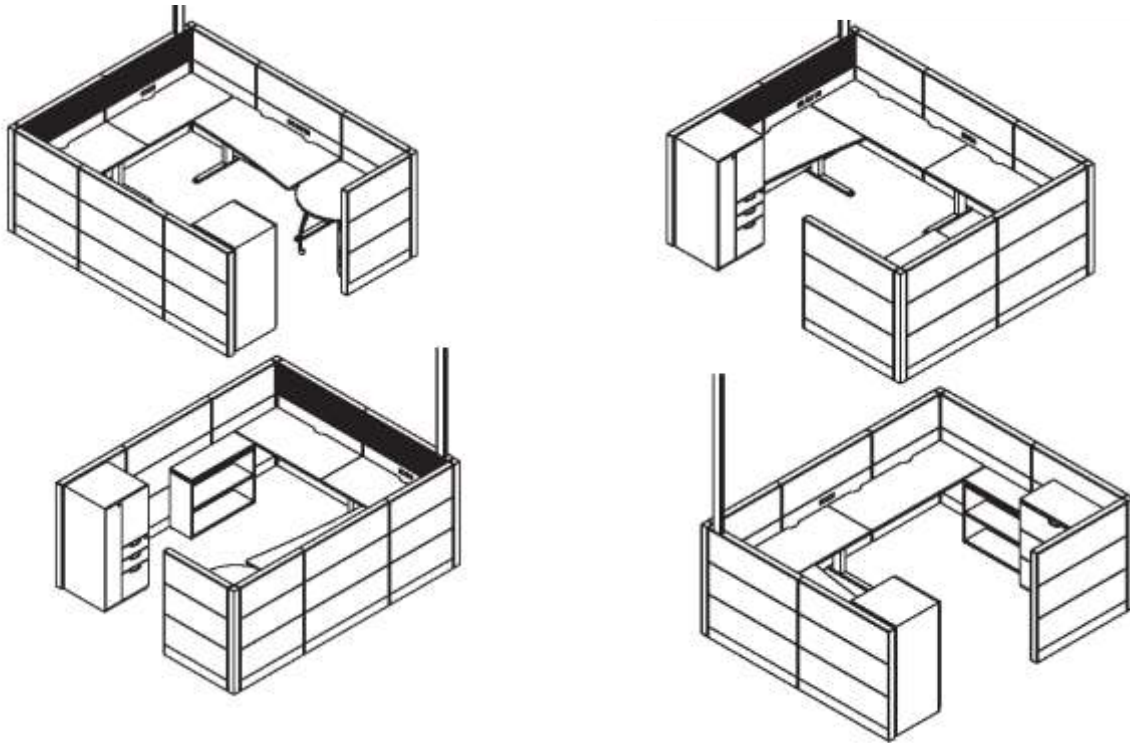

**TYPE C: ADMIN SUPPORT, TECHNICIAN**

WORKSTATION TYPE 'C' 60 ft<sup>2</sup>

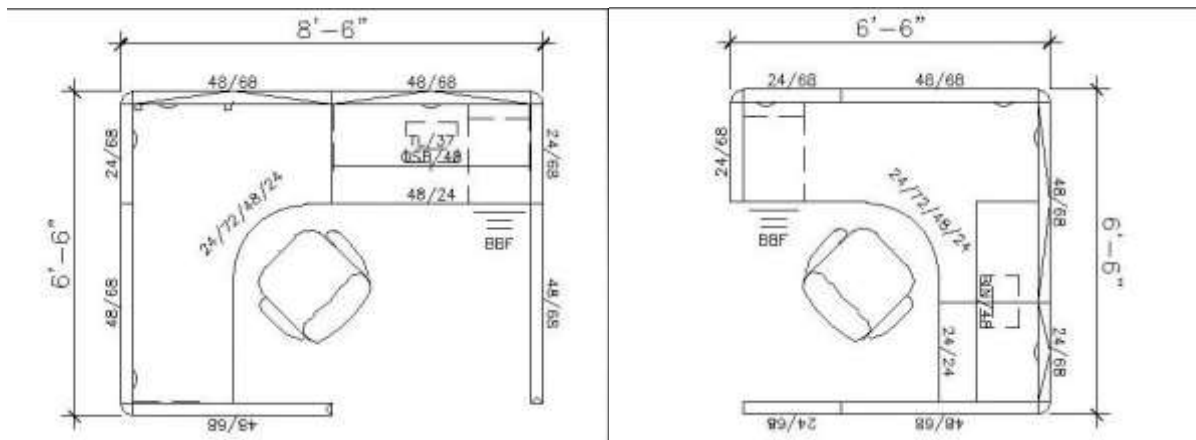

**TYPE D: TELECOMMUTER – HOTELER OCCASIONAL WORKER – Touch-down**

**WORKSTATION TYPE 'D' 36 ft<sup>2</sup>**

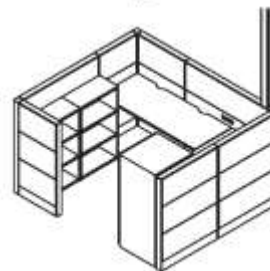
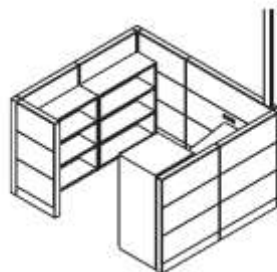
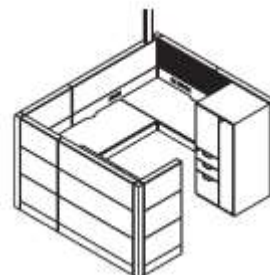
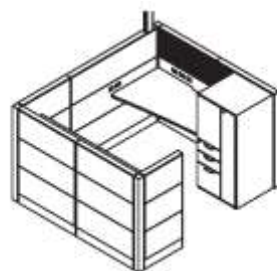
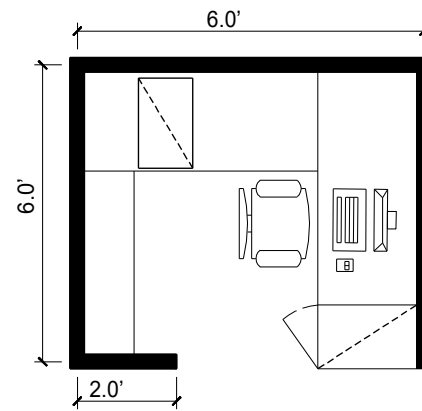
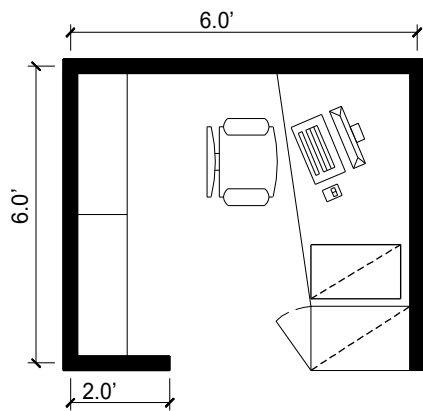

## **Office Support Space**

The planning template includes a selection of three types of meeting facilities.

The Standards recommend that the meeting rooms be designed with multiple telecommunication service outlets and be equipped with modular furniture, allowing the table layout to be reconfigured.

Conference Room (2-5 Persons)	100
Conference Room (5-8 Persons)	150
Conference Room (8-14 Persons)	250
Open Teamwork Area	100
Quiet Room	50

Small Meeting Room: Seats up to 6 persons – 100 ft<sup>2</sup>

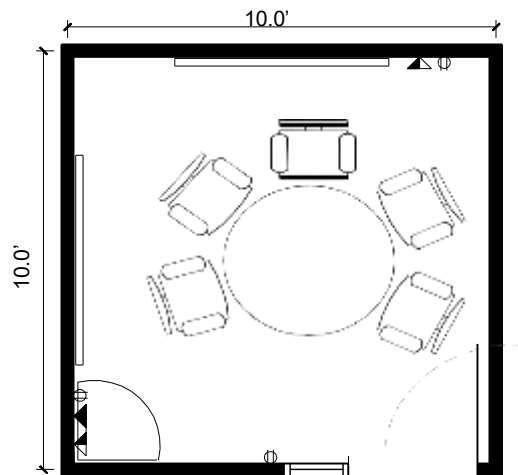

Medium Meeting Room: Seats up to 15 persons – 150 ft<sup>2</sup>

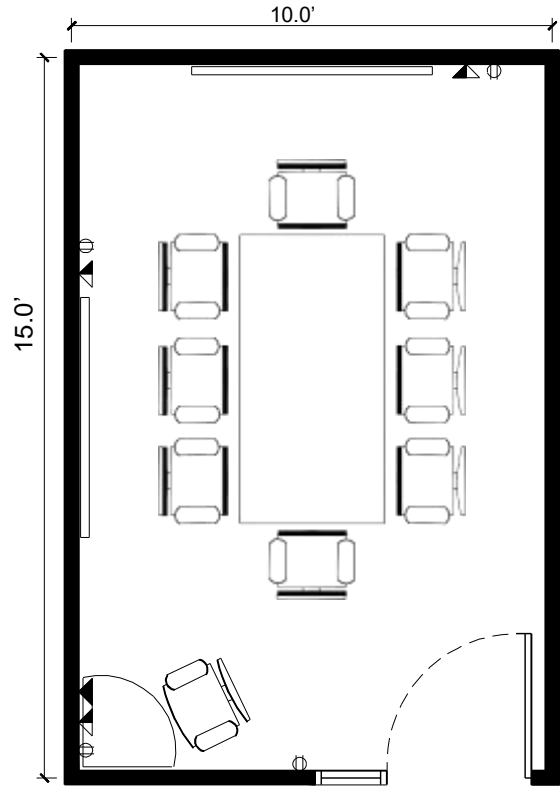
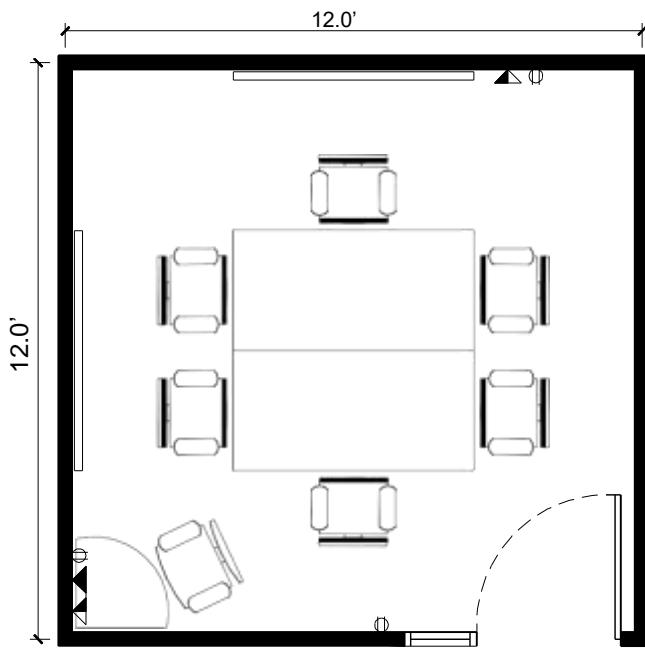

Large Meeting Room: Seats up to 25 persons – 250 ft<sup>2</sup>

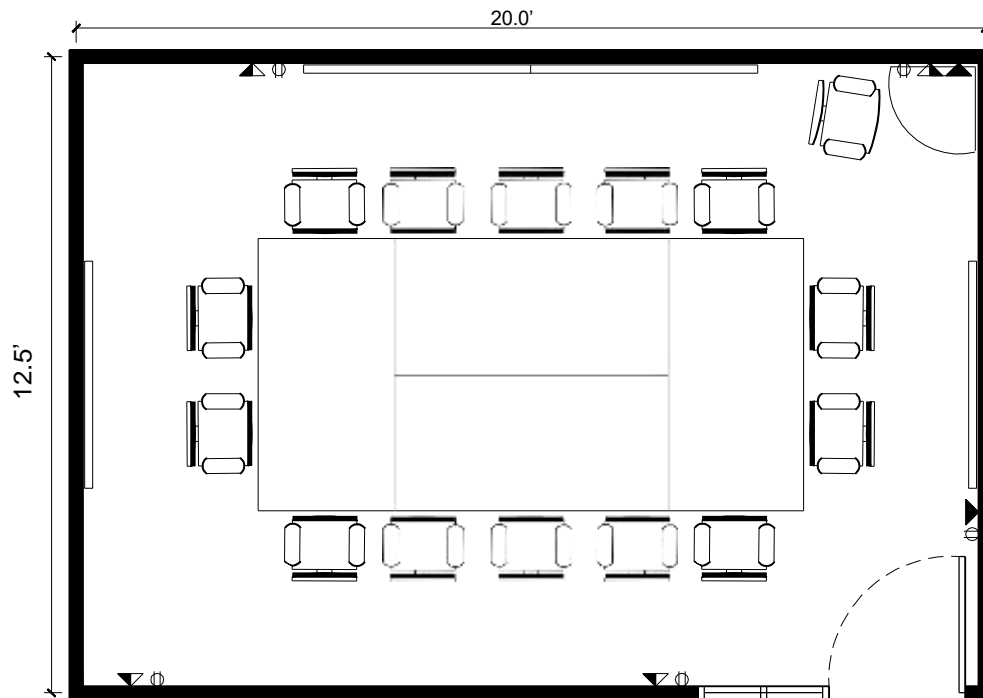



### Open Teamwork

Open Teamwork areas, also known as *huddle areas*, are for informal spontaneous meetings that can lead to great outcomes. Open Teamwork meetings require no reservation, have an informal character and don't necessarily have an agenda. Just as the character of the meeting, the room should be designed to accommodate free spirited joining.

File Storage and Open Team Area

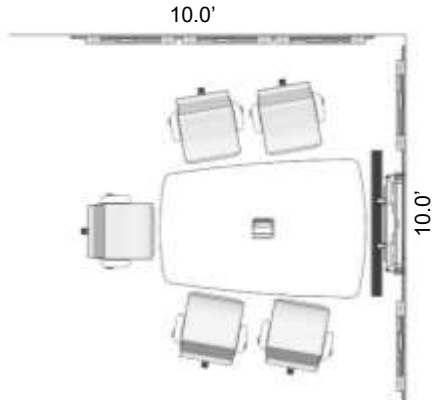

### Quiet Room

A Quiet Room is a 2-person meeting or workspace. Quiet rooms are intended to serve as unscheduled meeting or workspace areas, accommodating private telephone calls or teleconferences. The rooms must have standard telecommunication service for staff that have access to portable devices.

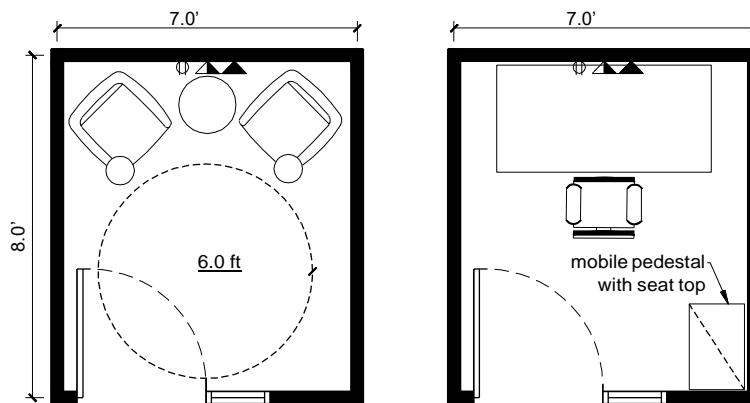

## Shared Office Spaces

### Beverage Counter or Kitchenette – 84.0 ft<sup>2</sup>

The area allocation for this function is recommended to include double sink as well as space for a refrigerator, microwave enclosure, water cooler, and trash/recycle containers. Can be designed into an informal meeting place where staff exchange information and generate ideas, creating a free-flow open-area function space.

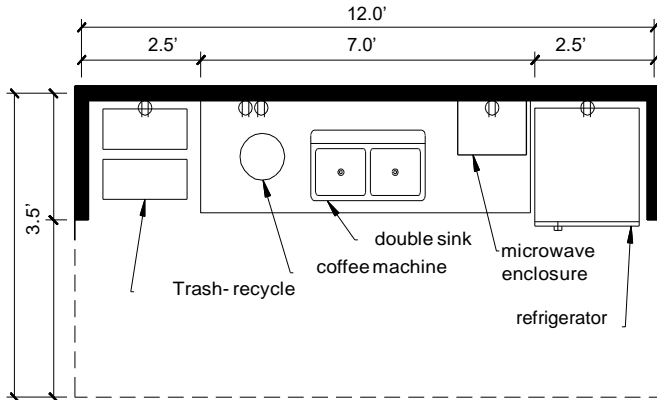

### Sample of Friendly Brake Gathering Area



## ***Public Spaces***

The front lobby is used to directly get in touch with customers and is usually the first place that customers get to when they arrive to the program office. The front office can discover more information about the customer by asking them questions, and also helping the customers out.

Small Reception – 30.0 ft<sup>2</sup> – Seats 1 to 2 persons

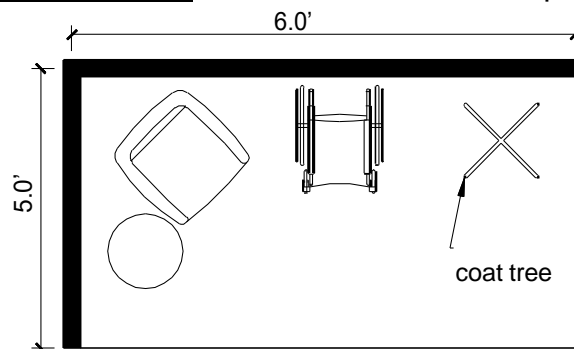

Medium Reception – 84.0 ft<sup>2</sup> – Seats 3 to 4 persons

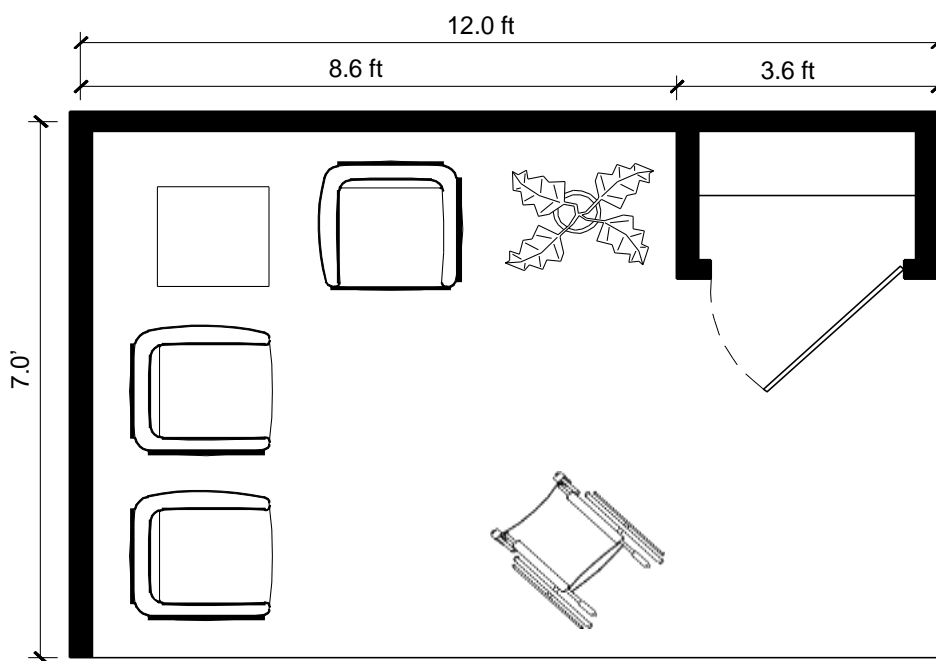

**Main Reception – 144.0 ft<sup>2</sup> – Seats 5 to 6 persons**

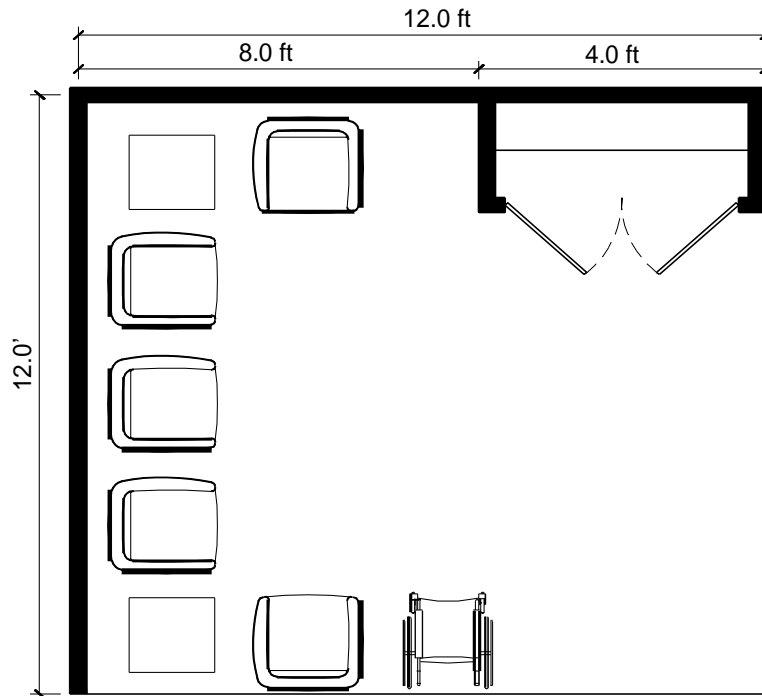

***Special Purpose Spaces***

Special purpose spaces are assessed individually for each program. Some of the specialized spaces includes secure interview rooms, large storage facilities, specialized equipment spaces, and dedicated training facilities that are used on a continuous basis.

**Secure Interview Rooms**

Interview rooms are suitable for meeting clients and are designed specifically to meet the program needs allowing staff to communicate with clients and ensures that clients are not given access to the work area and sensitive documents.

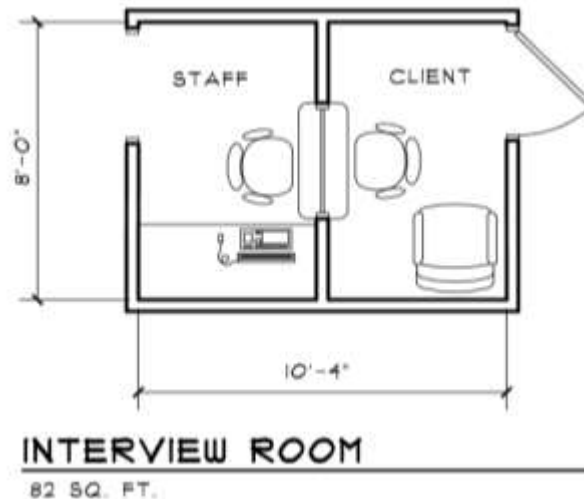

Phone Booth

Phone Booths provide privacy to customers when talking to a DCF representative, minimizing disruptions from the open-lobby area.

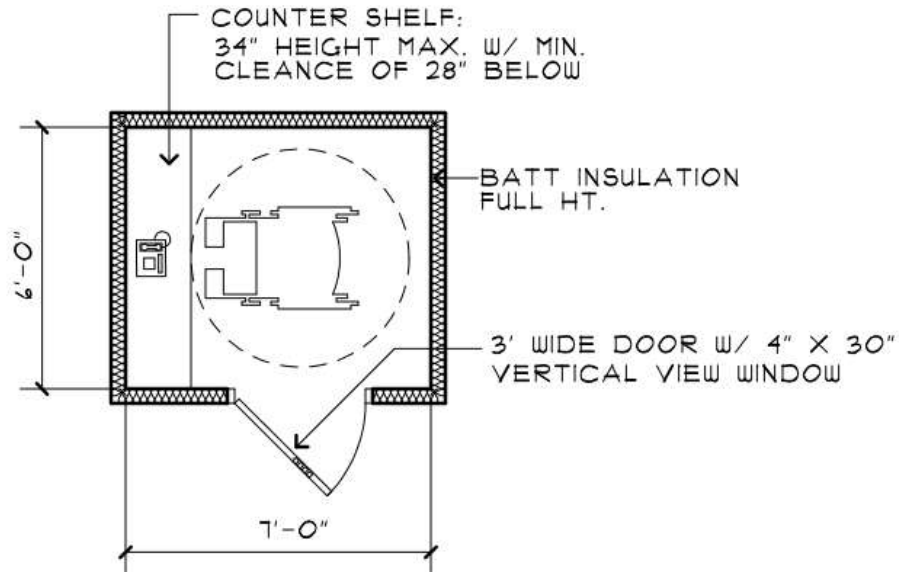

**PHONE BOOTH**

42 SQ. FT.

Storage

An allocation for storage space needed to accommodate stationery, forms, IT equipment, and general bulk storage is incorporated into the planning template. Space may be either a free-standing or an enclosed closet. Programs are encouraged to use high-density storage if their location has suitable floor loading.

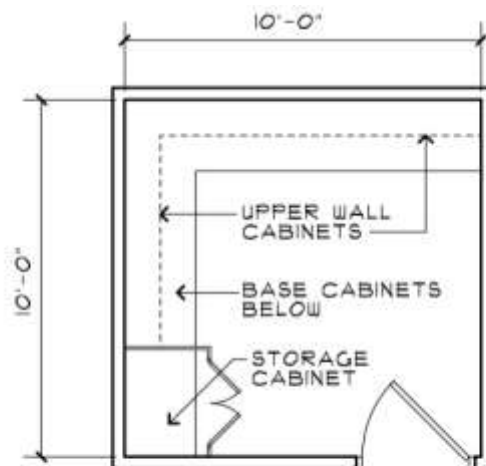

**STORAGE ROOM**

100 SQ. FT.

### Training Rooms

Training rooms are much more than spaces where employees come to sit and learn – they're dynamic environments where people meet, learn, share ideas and collaborate.

660 ft<sup>2</sup> – Seats up to 24 persons

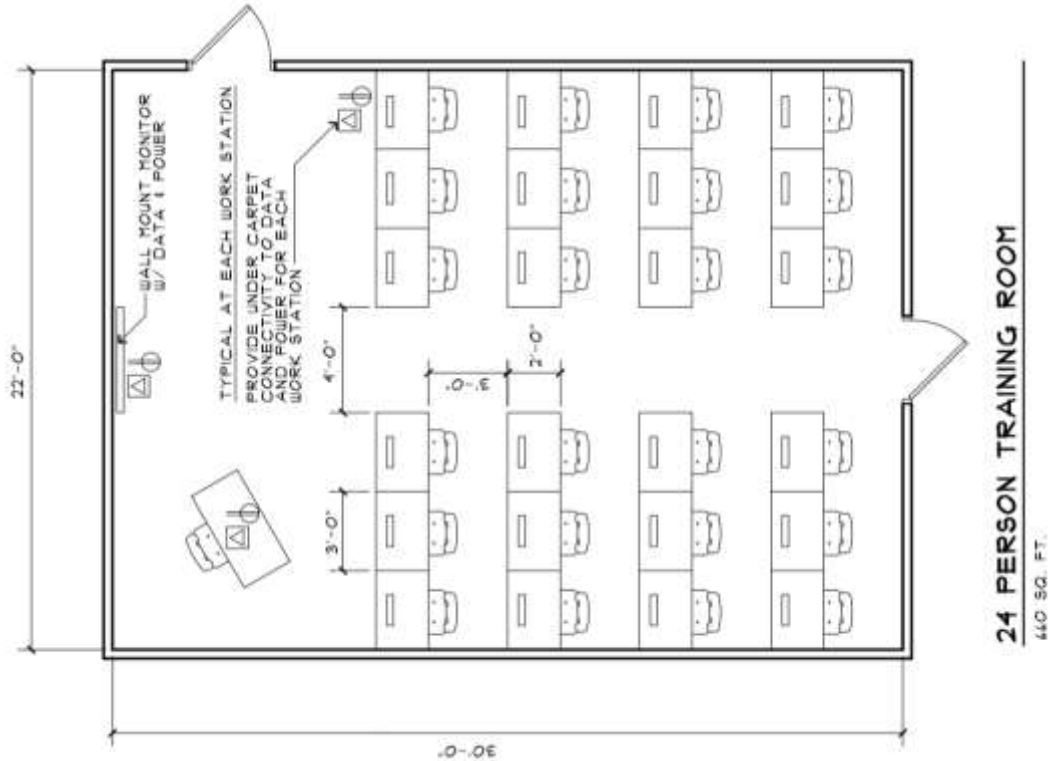

550 ft<sup>2</sup> – Seats up to 18 persons

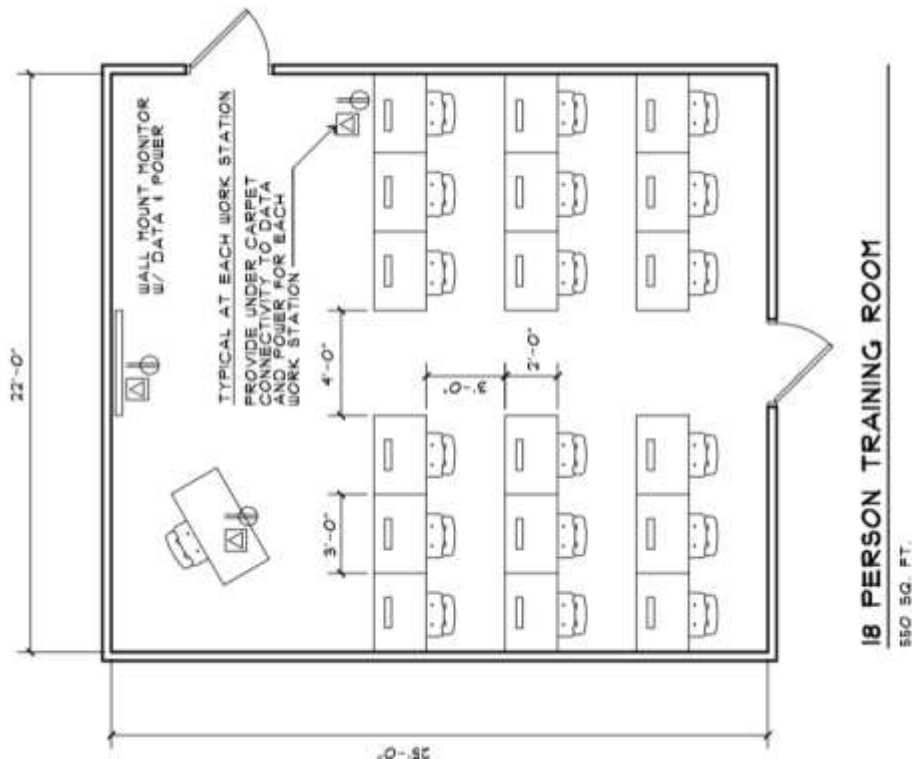

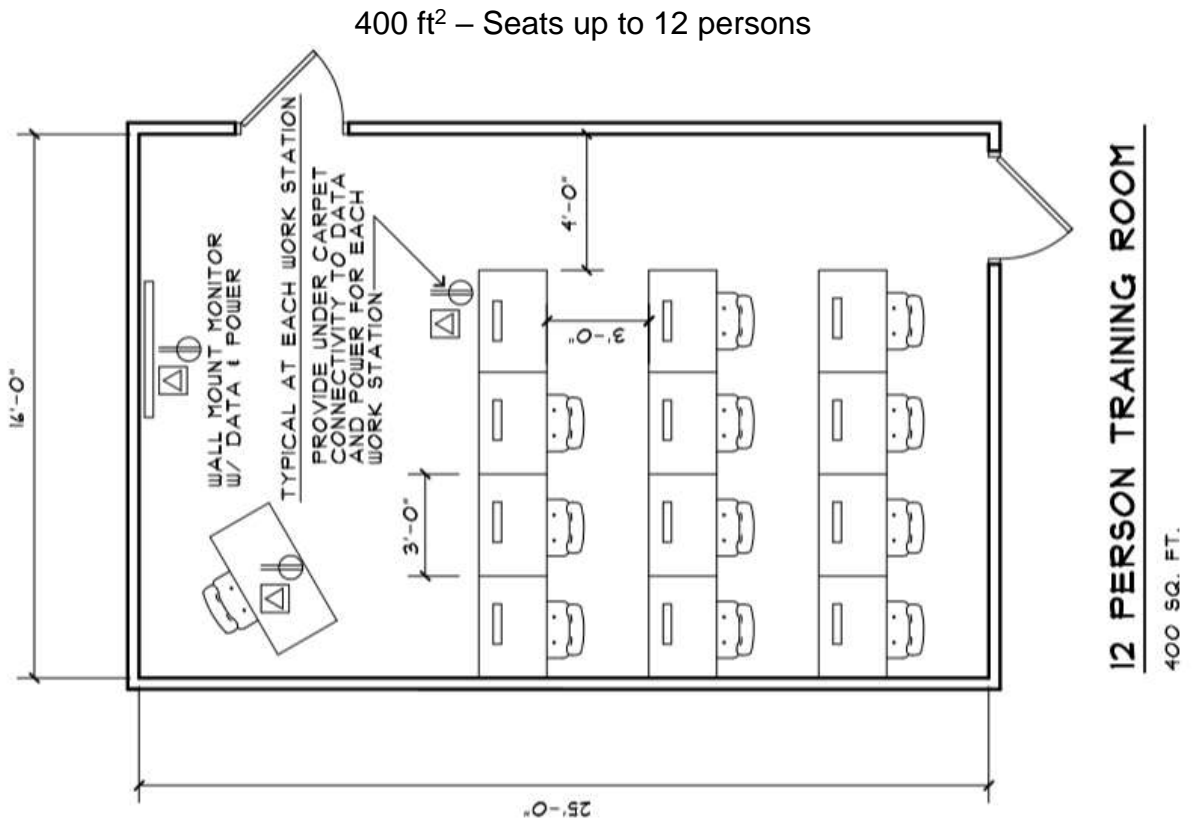

Equipment / Work Centre

Work Center – 150 ft<sup>2</sup>

